

April 2013
Volume 119
Issue 1924
£5.10

WIRELESS
WORLD

1913

Electronics WORLD

THE ESSENTIAL ELECTRONICS ENGINEERING MAGAZINE
www.electronicsworld.co.uk

The *Centenary* Issue



1981



Past

Arthur C. Clarke for
Wireless World



Future

All for one, one for all –
the future smartphone



We are **100** years old!

Need a True Automotive Expert?

Teledyne LeCroy Automotive Oscilloscopes



Efficient Automotive Design and Debug

Leading Technology

- 8 Channel Solution
- HD4096 True 12-bit Technology:
 - 16x More Vertical Resolution,
 - Unmatched Measurement Precision
- 36 Digital Channel Mixed Signal Solution

Widest Range of Serial Data Tools

- CAN, LIN, FlexRay™
- MOST, BroadR-Reach, SENT, PSi5
- Manchester & NRZ Configurable Protocol Decode
- I²C, SPI, UART, Ethernet, USB, PCI-Express etc.

teledynelecroy.com/europe



TELEDYNE LECROY
Everywhere you look™

Cover prepared by
LINEAR TECHNOLOGY
More on pages 8-9

- 05 FROM THE EDITOR**
100 Years in Print
- 06 TECHNOLOGY: THEN AND NOW**
- 10 ELECTRONICS WORLD SURVEY**
introduced by **Svetlana Josifovska**
- 14 FROM THE ARCHIVES:**
'Extra-Terrestrial Relays' by **Arthur C. Clarke**
introduced by **Svetlana Josifovska**
- 20 FROM THE ARCHIVES:**
'Current Dumping Audio Amplifier' article by **P. J. Walker**
introduced by **Jan Didden**
- 26 Q&A**
with **Bob Dobkin**, Co-founder and Chief Technical Officer of Linear Technology
- 28 ACCELERATING PRODUCTIVITY, INNOVATION AND DISCOVERY SINCE 1976**
National Instruments (NI) has spent 36 years pioneering technological breakthroughs that make engineers' lives easier. See what's coming next. By **Dr James Truchard**, President, CEO and Co-founder of National Instruments
- 32 OSCILLOSCOPES EVOLVE TO FIT THEIR TIMES**
From mechanical to analog to digital, and from 6-bit to 12-bit architectures, oscilloscopes have stayed a step ahead of the signals they measure. By **David Maliniak**, Technical Marketing Communications Specialist at Teledyne LeCroy
- 36 HOW SEMICONDUCTOR SOLUTIONS HELPED THE AUTOMOBILE TO EVOLVE**
Sabine Jud, Automotive Marketing Manager at ams, looks at the near-future trends in the automotive sector
- 38 ENGINEERING THE WORLD**
Hagop Kozanian, Vice President for Worldwide Analog Marketing at Texas Instruments, discusses the analog, embedded processing technologies that deliver innovative solutions that are changing the world
- 42 LIVING IN AN ERA OF TECHNOLOGY REVOLUTION**
As his company turns 20, Ciena's **Mervyn Kelly** takes a stroll down memory lane, looking back at years of innovation in the high-tech industry
- 46 KEY TRENDS ON THE TECHNOLOGY FRONTIER**
Monty Barlow, Associate Director of Wireless at Cambridge Consultants, looks into the future of technology, from the way data will be used and managed, through futuristic use of images and video, to the potential shortage of RF spectrum

- 50 SMART CITIES OF TOMORROW**
What will the smart cities of tomorrow look like? **Joseph Alderson**, Technical Marketing Engineer at Farnell element14, observes the growing factors that accelerate the need for better instrumented, interconnected and intelligent infrastructure, and discusses the future technological innovations
- 54 VEHICLES OF THE FUTURE – SEEING AND THINKING**
Lars Reger, VP of Research and Development and Strategy at NXP Semiconductors, says that semiconductors are the key to simple, secure, safe and convenient mobility in the world's megacities
- 60 CAN IN AUTOMOTIVE APPLICATIONS: A LOOK FORWARD**
Nicolas Navet (INRIA/RealTime-at-Work) and **Hervé Perrault** (PSA Peugeot-Citroën) look at the past and future of the CAN bus in automotive applications
- 64 CONNECTORS – THE MARVELS OF ENGINEERING DESIGN**
Bill Henderson, Industry Director for Aerospace and Defence at Hypertac, goes over the strengths of connectors as wonders of engineering design
- 66 CIRCUIT PROTECTION INNOVATION OVER THE YEARS**
Robert Hilty, Senior Director of Engineering of TE Circuit Protection, charts his company's history through its products
- 68 RELEASING THE MUSIC IN THE GOLDEN GATE BRIDGE**
Making sound art with accelerometers, charge amplifiers and microphones, **Bill Fontana** enhances our perception of sounds by revealing how structures hum with an unseen rhythm
- 72 THE END OF THE ROAD**
Do experimental results mean the end of the road for what has been taught to 14-year-olds throughout the world for 150 years? They are taught that a "steady charged capacitor" has static electric charge sitting on the two plates. By **Ivor Catt**
- 76 THE CHALLENGES OF USING CONFLICT-FREE MINERALS WITHIN THE ELECTRONICS INDUSTRY**
Karen Mascarenhas reports on sourcing conflict-free minerals within the electronics industry
- 80 PRODUCT OF THE MONTH**
- 82 PRODUCTS**

CONGRATULATIONS
to **ALAN PRATT**, Principal Microwave Engineer at MM Microwave, who won a Kindle Fire in our recent competition organized by Binder

Disclaimer: We work hard to ensure that the information presented in Electronics World is accurate. However, the publisher will not take responsibility for any injury or loss of earnings that may result from applying information presented in the magazine. It is your responsibility to familiarise yourself with the laws relating to dealing with your customers and suppliers, and with safety practices relating to working with electrical/electronic circuitry – particularly as regards electric shock, fire hazards and explosions.

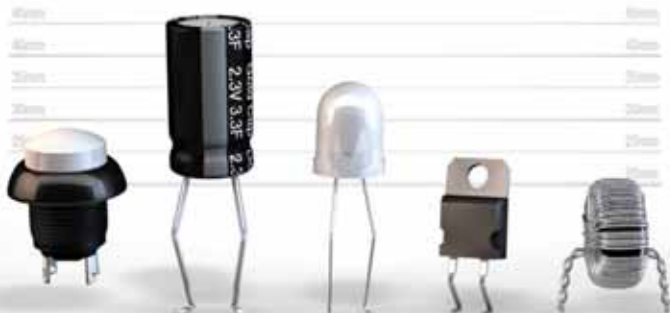

**Make us part of your electronics line-up.
FIND IT. DESIGN IT. BUY IT.**

rswww.com/electronics



Be Prepared with the Agilent FieldFox Combination Analyser from Microlease.



Dark, rainy, windy, dusty, slippery, glaring, scorching. For you, the unpredictable is the everyday. But there's one thing you can always depend on: the Agilent FieldFox Combination Analyser. At a compact kit-friendly 6.6 lbs.(3 kg.), it's three instruments in one: Cable & Antenna Analyser (CAT) + Vector Network Analyser (VNA) + Spectrum Analyser. Now available from Microlease.

FieldFox Combination Analysers

Four models up to 26.5 GHz

MIL-PRF-28800F Class 2 rugged

Agrees with benchtop measurements

CAT + VNA + Spectrum Analyser

**Buy from Microlease,
Agilent's Authorized Technology Partner**

info@microlease.com

+44 (0) 20 84 200 205

www.microlease.com/agilent

Demo and 1 week FREE evaluation for the new FieldFox available from Microlease. Scan the QR code or visit www.microlease.com/AgilentFieldFox



microlease

The experts in Test Equipment management



Agilent Technologies

Authorized Technology Partner

ONE HUNDRED BIRTHDAY CANDLES FOR US

This is a big year for Electronics World: it's our Centenary year, when we celebrate 100 years in print. This indeed is a rare and unusual occasion, and not many engineering titles can boast such a feat.

To mark the event we have made the articles informative and fun, looking back in time but also looking forward. After all, we hope this issue will be a collector's item, so the content should be able to stand the test of time.

One of the Centenary features is the Arthur C. Clarke's famous article first published in 1945 in Wireless World – the original name of Electronics World – on geostationary satellites, which are the foundation of modern-day satellite communications. This article also featured in the BBC's 'The Genius of Invention' programme broadcast on the 7th of February.

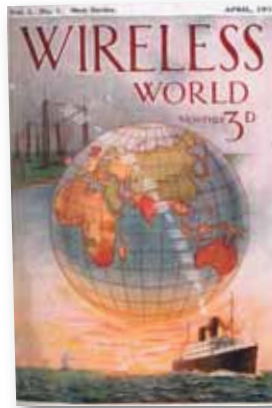

Electronics World was first published in 1913 as Wireless World. Over the past hundred years, the changing face of the industry has been reflected by updating our name and image

One of the Centenary features is the Arthur C. Clarke's famous article first published in 1945 in Wireless World – the original name of Electronics World

We have received many congratulatory messages already, as well as contributions from several large and well-known electronics companies that have been around a long time. In this issue they share their views of how electronics and the work of the electronics engineer have changed over the decades and how they see them shape in the years ahead.

So join us in celebrating this milestone, our first hundred years!



By Svetlana Josifovska, Editor

EDITOR: Svetlana Josifovska
+44 (0)1732 883392
Email: svetlanaj@sjpbusinessmedia.com

DESIGN: Tania King
Email: taniak@sjpbusinessmedia.com

DISPLAY SALES: John Stewart
Tel: +44 (0)20 7933 8974
Email: johns@sjpbusinessmedia.com

SALES EXECUTIVE: Orla Cullen
Tel: +44 (0)20 7933 8985
Email: orlac@sjpbusinessmedia.com

PUBLISHER: Wayne Darroch
ISSN: 1365-4675

PRINTER: Pensord Magazines
& Periodicals

SUBSCRIPTIONS:
Tel/Fax +44 (0)1635 879361/868594
Email: electronicsworld@cirldata.com
SUBSCRIPTION RATES:
1 year: £56 (UK); £81 (worldwide)

SJP
business media

Follow us on Twitter
@electrow

Join us on LinkedIn
<http://linkd.in/xH2HNx>



The Birth of the TV's Remote Control

Eugene Polley, inventor of the first wireless remote control, called the Flash-Matic (right)

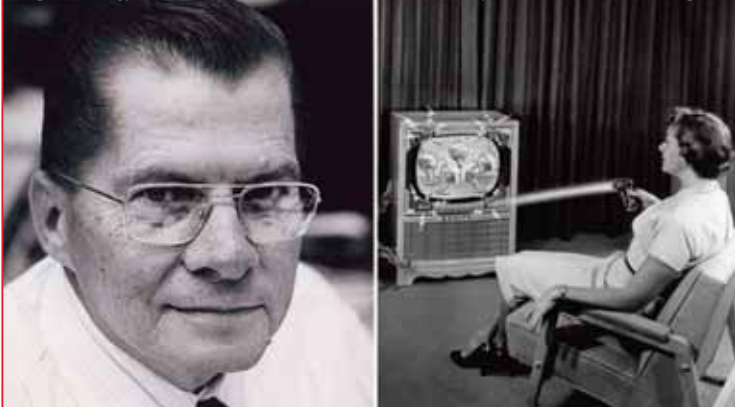

Back in 1955, an American inventor named Eugene Polley created the first wireless television remote

control. Dubbed "Flash-Matic", the device shone a beam of light at any one of four photocells in the corners

of a TV screen to switch the set on or off, change channels or mute the sound.

The original advert proclaimed "You have to see it to believe it" and described its method of working as a "flash of magic light".

But the early version of the remote control was not without its problems – sunlight would change the channel unexpectedly and, also, users would forget which corner of the screen produced which effect.

In 1960 Zenith Electronics, where Polley had worked since 1935, introduced the follow-up remote control in the form of the Zenith Space Commander, this time using ultra-sonic sound instead of light.

The infra-red remote control as we know it today did not appear until the early 1980s.

Polley died in May last year, aged 96. Trevor Baylis, the British inventor of the wind-up radio, said: "Mr Polley has shown that inventions can change all of our lives. Here is a guy who came up with a concept in 1955, and in those days everybody thought "we won't need that". And now the technology is absolutely amazing."

"We take these sorts of inventions for granted, but we should celebrate people like him who come up with brilliant inventions and make sure everybody knows their names," he added.

The Future of the Smartphone

You leave the house to go on holiday, lock the door behind you and start the car. At the airport, you pay for parking and go through security with your passport before boarding the flight.

On arrival, you check into your hotel and arrange for a transport pass for the duration of your journey, before swiping on to the metro and heading to the museum you already have a ticket for.

A common enough scenario. But, what if – instead of having keys, wallet, passport and printed tickets – every one of these interactions was performed wirelessly with your smartphone?

The established concepts of contactless payments, mobile wallets and mobile banking already signal major growth in the secure services that can be performed wirelessly. However, leading wireless technology design and development

firm Cambridge Consultants says the real business value of smartphones is yet to come, with a massive disruptive effect on a much broader selection of secure services – everything from IDs and passports to website logins, anti-counterfeiting and as a replacement for keys.

"We have barely scratched the surface of what smartphones, Near Field Communications (NFC) and secure element technology can do for secure services. Mobile wallets and ticketing are just the jumping-off point," said Jon Edgcombe, leader of the application software technologies group at Cambridge Consultants. "The short- and long-range wireless capabilities of smartphones are ripe to be exploited for a far greater range of secure applications – things like identity verification using face or voice biometrics, for example."

"We're just at the point where the

full potential of the technology for smartphones to be at the centre of secure services is starting to be fulfilled," he continued. "Although there are some technical challenges to overcome to get to that point, we firmly believe that smartphones will transform how consumers interact with a range of day-to-day secure items – not just your bank card and wallet, but also your house and car keys, your travel tickets, loyalty schemes, healthcare devices, even corporate access and beyond."

The smartphone has some inherent advantages that make this vision of the future possible. Not only is the device linked directly to an individual – and usually carried on their person at all times, but it offers a flexible user interface and processing platform. Moreover, increasingly the technology to secure the required connectivity, imaging or data processing capabilities is already embedded in the phone.

"The key limiting factor is access to the secure store of information on the device, and who controls this – the smartphone designer, the mobile network operator, a third-party "trusted service manager" or the end user. The last approach, where the end user controls the secure element in the same way you currently control which apps are on your smartphone, is gaining support

in some application areas.

Despite this uncertainty, many organisations are looking at ways to take advantage of the technology in order to open up a whole new world of products and services in medical, pharmaceutical, homecare, automotive, transport, energy and consumer markets.

"The opportunity for secure data collection, processing and communication has an immediate application in the increasingly valuable area of authentication and track-and-trace to secure supply chains against counterfeit or diverted products and other illegal activities, whilst providing an easily customisable and upgradeable set of applications and user interfaces to suit different stakeholders," said Edgcombe.

Such advancements in the technology of the smartphone are calling upon other industries to get involved, for example the security sector.

"The ubiquity of smartphones and their technical capabilities means the security sector has to start thinking far more intelligently about the potential applications," added Ian Lancaster, director of Reconnaissance International, experts in brand and document security and the holography, authentication and tax stamp markets.

The future of the smartphone looks promising as a single device for many secure applications





www.xjtag.com



XJTAG boundary scan traces untraceable faults for leading defence contractor

“XJTAG visited Indra in Spain to demonstrate boundary scan testing for high-value avionic boards. Presented with a batch of failed units that had defeated previous attempts at diagnosis, XJTAG quickly tracked down every fault, enabling the boards to be repaired. Indra now uses XJTAG in several development and production departments.”

Indra is a €3 billion technology multinational, headquartered in Spain and active globally in sectors such as transportation, energy and industry, healthcare, telecommunications and defence. Seeing innovation as central to differentiating its solutions and adding value for customers, Indra has a network of centres of excellence specialising in specific technologies and expertise. The company is also adept at leveraging talent in other organisations, such as partners that are leaders in their own fields, to keep driving the pace of progress.

Indra invited XJTAG to show how boundary scan could enhance test and diagnostic capabilities for Eurofighter avionics boards produced at the company’s factories near Madrid. The high-value circuit boards are built on a metal-alloy substrate for reliable operation over a wide temperature range. The nature of the substrate, however, challenges assembly processes such as soldering.

Functional tests had proved capable of identifying defective boards. However, once isolated from the production process, these boards had resisted engineers’ efforts to diagnose and remedy the faults.

Upon arrival, XJTAG’s engineers were invited to test five undiagnosed boards to demonstrate the system’s abilities. The team quickly traced the first board’s fault to an open circuit between two pins. Indra engineers then examined the connections using a microscope, discovering a tiny break in one solder joint that confirmed XJTAG’s diagnosis. After repair, the board successfully

passed the functional test routine it had previously failed.

The XJTAG team also diagnosed the remaining boards in the failed batch, quickly pinpointing defects including hard-to-find faults underneath BGA devices. Since each board is worth



around €10,000, this short yet productive visit highlighted the value of boundary scan to Indra’s work on Eurofighter as well as other projects.

“XJTAG showed that boundary scan could help us overcome the challenges we face when assembling advanced, high-performance electronics. To be sure of making the right choice, we then evaluated other competing systems,” comments Sergio Navacerrada Castaño, Technology and Product Manager. “XJTAG was the best suited to our needs, offering flexibility, graphical layout and schematic views, and features to simplify project setup. Moreover, the price is very competitive versus other systems and there are no additional charges for using advanced features.”

Indra has now invested in several XJTAG licenses and uses the XJTAG Professional development system, XJAnalyser and XJRunner, which is optimised for production-line use by OEMs or contract manufacturers. “With the help of XJTAG’s engineers, as well as access to the API and hardware devices such as XJLink2 and the XJIO expansion boards, we have also integrated boundary scan with some of our in-circuit and functional test platforms to enhance test coverage and efficiency,” comments Joaquín Martínez Bonilla, Project Manager at Indra.

Sergio Navacerrada Castaño adds, “The XJTAG system has impressed us from the first encounter. We are now using it with most of our projects, from development through to production.”

opinion

Sergio Navacerrada Castaño
Technology and Product Management
Indra

“XJTAG showed that boundary scan could help us overcome the challenges we face when assembling advanced, high-performance electronics. It is feature rich, easy to use, and the price is very competitive versus other systems, with no additional charges for using advanced features.”

“XJTAG has impressed us from the first encounter. We are now using it with most of our projects, from development work through to production.”

Data Bank	
Company	Indra, HQ Spain
Nature of business	Global technology, innovation and talent company
Main product	Cutting edge of high value-added solutions and services
Customers	Transport & Traffic, Energy & Industry Public Administration & Healthcare, Financial Services, Security & Defence and Telecom & Media sectors
Location	Madrid, Spain Operates in more than 118 countries
Employees	40,000 professionals worldwide
Web site	www.indracompany.com

WIRELESS SENSOR NETWORK CHALLENGES AND SOLUTIONS

By Lance Doherty, Systems Engineer, Jonathan Simon, Systems Engineering Director and Thomas Watteyne, Systems Engineer, Dust Networks Product Group, Linear Technology Corporation

BACKGROUND

While both low-power sensors and wireless networking are now ubiquitous, there are still relatively few examples on the market of low-power wireless sensor networks. This is not for lack of interest – wireless sensors promise to cut installation costs dramatically, and provide access to data previously impossible or prohibitively expensive to obtain. While sensors have become smaller, less expensive, and lower power, installation costs have not kept pace: labor for wiring in new construction dwarfs the cost of a switch. When retrofitted into an existing building, or in an industrial process control environment, per-sensor installation costs can be hundreds or thousands of dollars.

With such strong cost motivation, why have wireless sensor networks (WSNs) not come to dominate the market? Two factors—radio power and network reliability—have kept WSNs largely “niche” products.

TECHNOLOGY CHOICES

Customers want a technology that is low cost, allows unrestricted sensor placement, reliable and quick data reporting, and runs for years with no battery changes. Recent advances in low-power radios and communications protocols have enabled us to deliver those features in many markets.

Data collection applications typically involve large numbers of sense points forwarding data to a central host that may respond with a process set-point or other configuration changes. There are several technologies competing to fill this role, including satellite, cellular, Wi-Fi, and IEEE 802.15.4-based solutions.

Satellite and cellular have the highest energy cost per packet, and are generally unsuitable for battery powered applications. These solutions make sense only for applications sending at a very low data rate (e.g., one data packet per day) with known good connectivity.

Wi-Fi (IEEE 802.11b, g) sensors are now widely available. The energy cost for a Wi-Fi packet is much lower than cellular, but still high for battery powered operation. Connectivity and coverage remain important concerns, as the density of access points necessary for reliable communication with a fixed sensor is typically high.

The IEEE 802.15.4 standard defines a physical layer (PHY) and Medium Access Control (MAC) layer for short-range, low-power operation, ideal for WSNs. IEEE 802.15.4 forms the basis of several proprietary and standards-based protocols including ZigBee unsynchronized single-channel networks, and WirelessHART1 time-synchronized multichannel networks. Using Linear Technology's LTC5800-IPM802.15.4 Mote-on-Chip™, sending a few bytes of sensor data, with routing, cryptography, and other headers uses under 30µC of charge, including receiving a secure link-layer acknowledgement (see Figure 1).

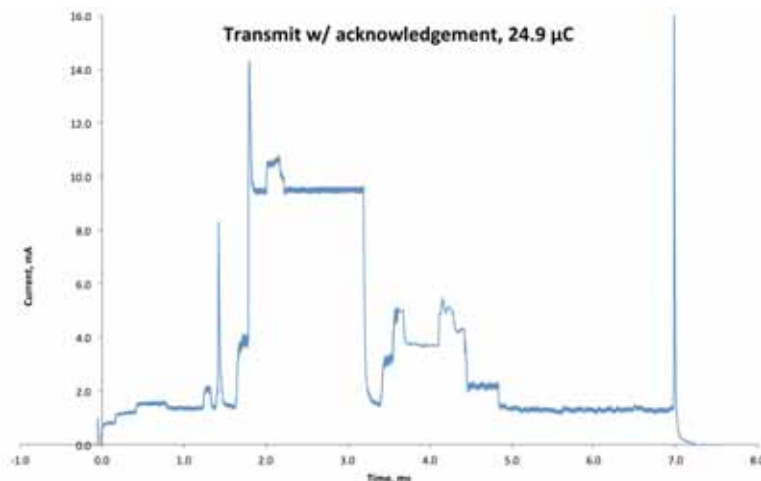

Figure 1: Energy to transmit a short 802.15.4 packet and receive an acknowledgement

MESH NETWORKS

Reliability is a concern when transitioning to wireless systems. The wireless channel is unreliable in nature, and a number of phenomena can prevent a transmitted packet from reaching a receiver – these can be exacerbated as radio power decreases.

Interference occurs when multiple transmitters send at the same time and frequency. This is particularly problematic if they cannot hear each other (the “hidden terminal problem”). Backoff, retransmission, and acknowledgement mechanisms are required to resolve collisions. Interference can come from within the network, another similar network operating in the same radio space, or from a different radio technology operating in-band—a common occurrence in the band shared by Wi-Fi, Bluetooth, and 802.15.4.

A second highly varying phenomenon called multipath fading can prevent successful transmission even when the line-of-sight link margin is expected to be sufficient. This

occurs when multiple copies of the transmission bounce off objects in the environment (ceilings, doors, people, etc.) all traveling different distances. When interfering destructively, fades of 20-30dB are common. Multipath fading depends on the transmission frequency, device position, and on every nearby object – predicting it is practically impossible.

Because objects in the environment move, the multipath effect changes over time, and it is unsafe to rely on any particular connection between devices, or path, to be useable forever. Figure 2 shows the packet delivery ratio on a single wireless path between two industrial sensors over the course of 26 days, and for each of the sixteen channels used by the system. At any given time some channels are good (high delivery), others bad, and still others highly varying. Importantly, there was no period observed where a channel was good on all paths everywhere in the network.²

Because of interference and multipath fading, the key to building a reliable wireless system is to exploit channel and path diversity. In a mesh network, sensors can forward radio packets from peers, extending the range of the network far beyond the range of a single radio, and providing the network with immunity to any single radio link failure. Using a Time Division Multiple Access (TDMA) scheme mitigates self-collision and allows for predictable network scaling.

Several mesh protocols are available for sensor networking: 802.11s for Wi-Fi, various ad-hoc routing protocols such as those used in ZigBee, and Linear Technology's Time Synchronized Mesh Protocol, which forms the basis of the WirelessHART and 802.15.4e standards.

SOLUTIONS

Key selection criteria for a WSN technology are cost of ownership and flexibility. Wireless technologies reduce installation costs dramatically compared to wired solutions, but battery changes needed for lifetime goals increase total ownership costs. Protocols must be designed to scale both in density and total number of sensors, to tolerate interference, and survive the loss of individual devices.

WSNs must be designed to work reliably in environments with wide temperature variations, and with link-layer packet delivery ratios (PDR) down to about 50%. For industrial applications, the reliability target is typically to receive at least 99.9% of the generated data, as missing data can trigger expensive alarm conditions. The system must support some minimum number of sensor data packets per second with bounded latency – “stale” packets are typically discarded and count against reliability.

APPLICATIONS

Linear's Dust Networks SmartMesh™ product line contains both WirelessHART and 6LoWPAN-compliant IPv6 product offerings that leverage 802.15.4 to provide the most reliable, lowest power, secure WSN solutions on the market. Dust Eterna™ motes (LTC5800 family) are single chip devices that couple a Cortex-M3 microprocessor, memory, and peripherals to the lowest power 802.15.4 radio available today. Designers embed a mote in their sensor package, and can rely on the network to form, optimize, and carry their sensor data to their application. Dust's managers allow for graceful scaling from tens to thousands of devices, providing data and configuration interfaces for the network. Both product families build highly reliable, multi-hop mesh networks capable of per-node configurable data rates. Some examples of applications using

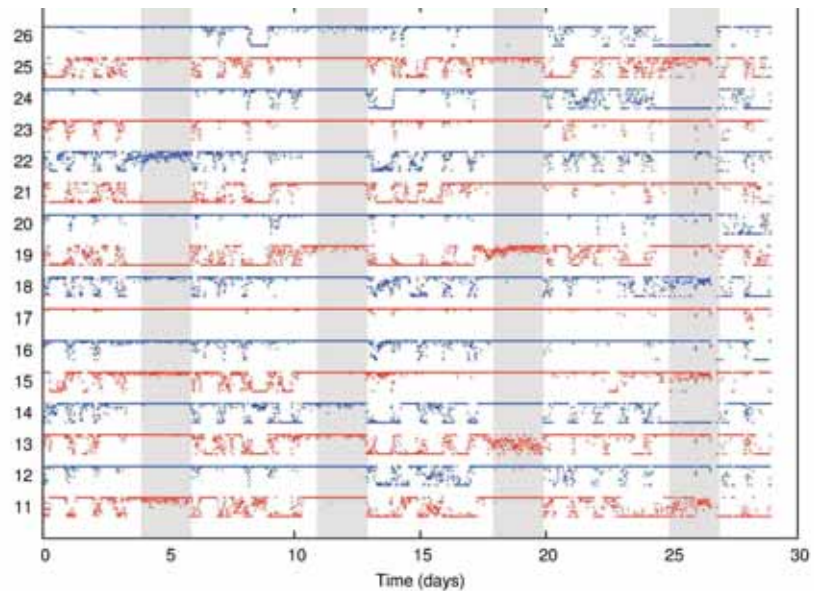

Figure 2: The packet delivery ratio of a wireless link evolves over time

Dust motes and managers include:

Parking – Streetline3 is a smart parking provider that monitors real-time parking space availability with vehicle detectors underneath the spaces and aggregates information into a citywide database. Low-power wireless technology is critical for this application because it is intractable to wire sensors to each space, and path diversity is essential as different vehicle positions change the path quality between device pairs.

Energy Monitoring– Vigilent4 provides intelligent energy

management systems for data centers, where air conditioning is often run continuously at full power, wasting energy. Vigilent deploys dense, secure wireless devices that do not interfere with regular data center operation, and has routinely deployed multiple overlapping networks to achieve the required number of sensors.



CONCLUSION

Multichannel time-synchronized mesh networks based on 802.15.4 radios address many of the challenges involved in building flexible, reliable, low-power wireless sensor networks.

REFERENCES

1. http://www.hartcomm.org/hcf/documents/documents_spec_list.html
2. L. Doherty, W. Lindsay, J. Simon, K. Pister, "Channel-Specific Wireless Sensor Network Path Analysis," Proc. ICCN '07, Honolulu, HI, 2007.
3. <http://www.streetline.com/>
4. <http://www.vigilent.com/>

THE NEXT 100 YEARS

It is almost impossible to avoid technology as we are so intricately involved with it. As electronic systems permeate every sphere of our lives, it is easy for some to assume that one day our world will be run by self-replicating artificial intelligence.

Alas, not so. According to the American computer scientist J C R Licklider, 'more of the same' is the most likely scenario, where computers and machines complement human intelligence. As such, technology will continue to shape our world and influence it, albeit possibly beyond our recognition today, as the rate of advancements accelerates. These effects will be experienced by all: from consumers and businesses, to society, governments and economies. So, can we predict the future of technology and as such our own future?

"You cannot look at the future in vague, general terms and get useful results," says Richard Worzel, a computer-science-degree holding futurist. He believes in breaking the future down into well-defined, specific segments and assessing what changes may come in these segments and what effect they are likely to have.

He continued: "If you consider that Moore's Law has been shown to be too conservative and that the pace of change is not only accelerating but the rate of accelerations is increasing, it becomes clear that the non-technological changes ahead of us

due to IT will be even more startling. In every sense, the IT revolution so far has merely achieved lift-off."

It is obvious that technology marches on at break-neck speed, so predicting the future five years ahead is almost as difficult as 100 years from now. Many company executives in charge of large, blue-chip companies at the forefront of research still struggle to define future trends.

"To spend time predicting the next [technological] wave, in our experience, is a futile exercise," says Hagop Kozanian, Vice President for Worldwide Analog Marketing at Texas Instruments.

Even those who have made successes of their businesses and are revered as industry veterans could not predict their own companies' future.

"Who would have thought we would be here today, 30 years down the line," said Bob Dobkin, co-founder of Linear Technology, which celebrated its 30th anniversary in 2011. "When we were starting, we were thinking five years ahead, and we thought that if we got to \$100 million dollars we would be a great company. History shows we blew through that revenue mark."

So, we asked our readers to comment on what they saw as the greatest technological achievements to date and what they expect in the future. Here are the results. ●

What do you think is the single most important development in the field of electronics in the past 100 years?

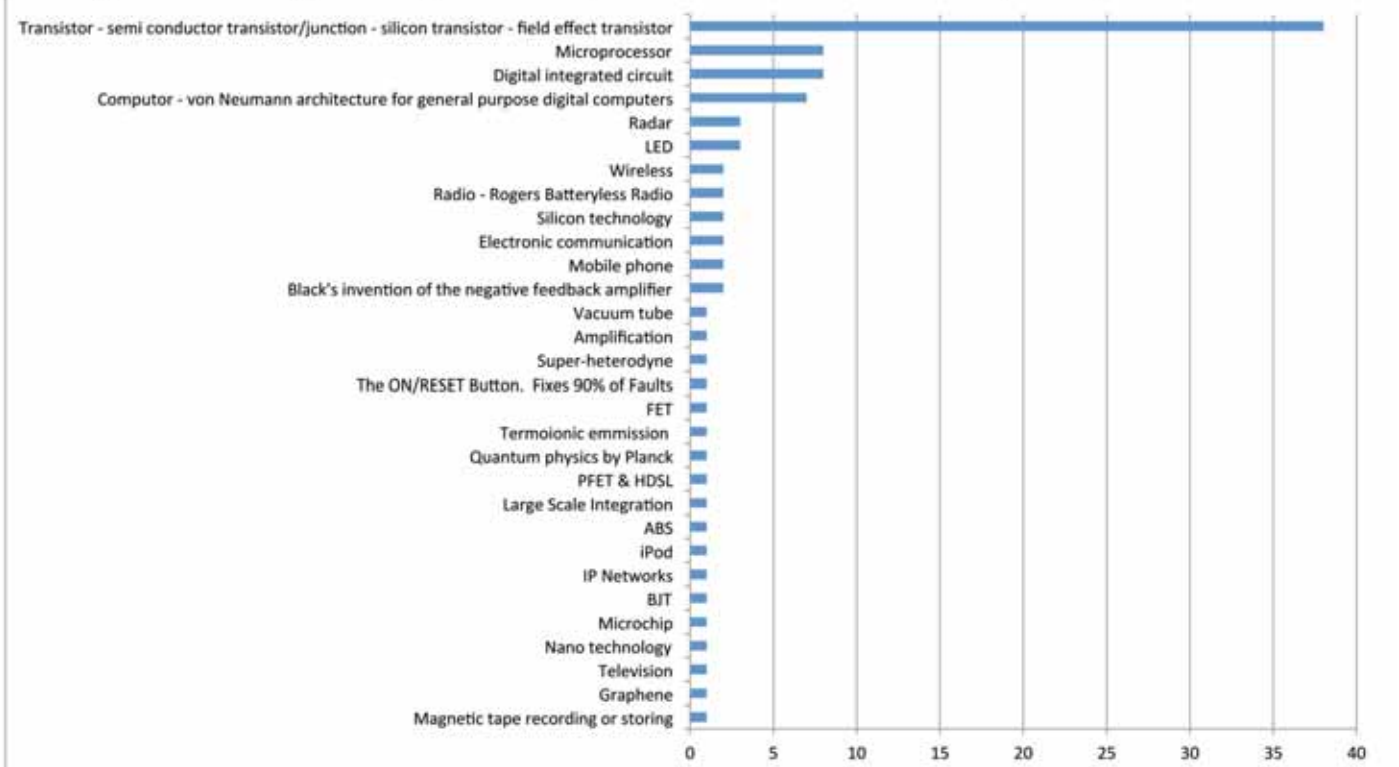

What will be the most important electronic development in the next decade?

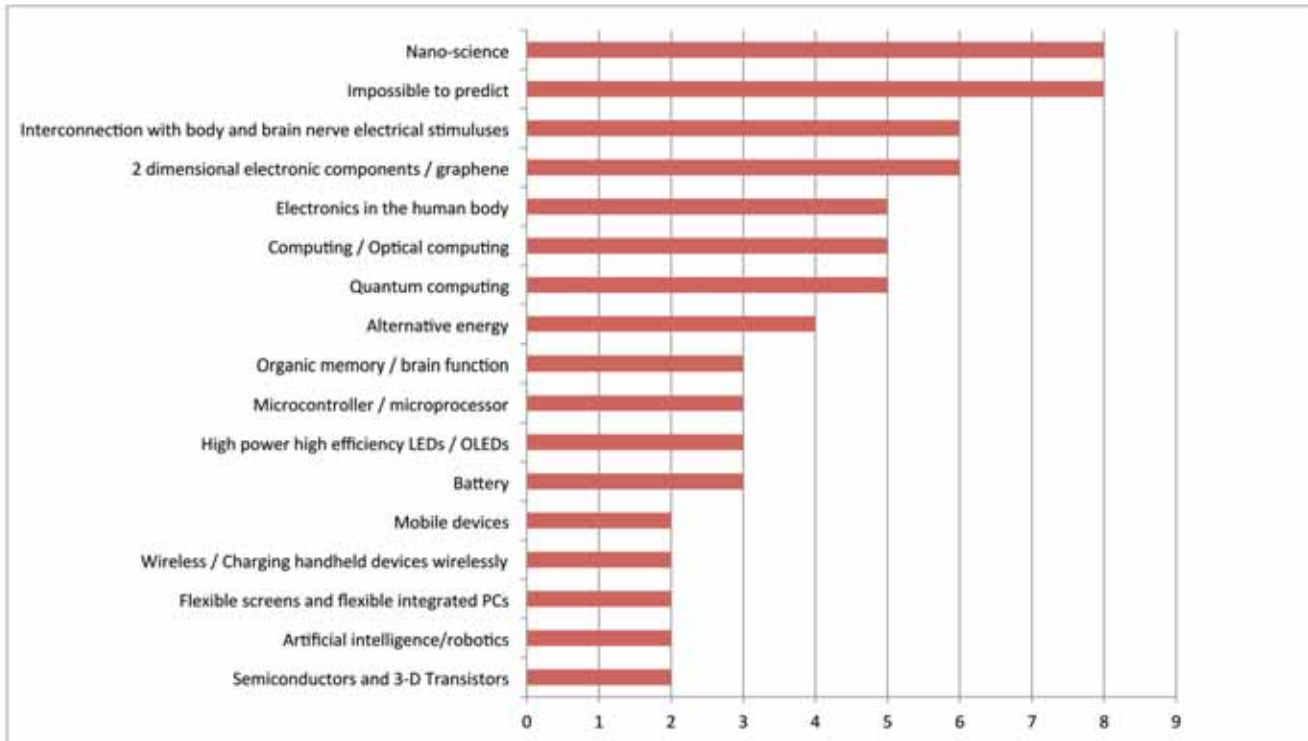

Past front covers of Electronics World are framed and line the walls of Linear Technology's HQ in Milpitas, US

He believes in breaking the future down into well-defined, specific segments and assessing what changes may come in these segments and what effect they are likely to have

OTHER TECHNOLOGIES OUR READERS THOUGHT DESERVE ATTENTION:

- Novel/biological electrically-active materials (bio-electrics)
 - A simple voltage switch using phase change material
 - Energy harvesting
 - Power saving technology
- Atomic scale computing and memory
 - Scalable, massively parallel processing devices
 - Circuit technology based on light
 - Distribution of products electronically
 - Holographics
- Read thought in each others' minds
 - Magnetic detection and control
 - Photovoltaic-oriented technology
 - Self-modifying adaptable circuits
 - Solving the spectrum problem
 - Teleporting

HAPPY BIRTHDAY ELECTRONICS WORLD!

Big Contribution to Society

A 1928 book proposed a stationary satellite [1], however, the idea is usually attributed to Arthur C. Clarke in his article in *Wireless World* (now *Electronics World*) in 1945 [2]. This was the biggest contribution to society by this journal. [All references can be found online at <http://www.ivorcatt.co.uk/x34.htm>]

On another note, in 1985 a letter in *Wireless World* listed some eight authors who could not be published anywhere else except in *Wireless World*. Perhaps the biggest case is myself and my co-researchers, who have published some 40 articles in the journal, while publishing virtually nothing elsewhere [3].

In 1978 I phoned the late Tom Ivall, Editor, pointing out that he had published material by Dr David Walton and Malcolm Davidson, my co-researchers. I told him that electronics was rapidly changing from analogue to digital, and we could supply the missing digital electronics expertise. In less than ten minutes he asked, "May I come and visit you?"

Tom came to St. Albans, which was followed by many of our articles being published in this journal. After a short while I told him that we also had controversial material, to which he replied: "We welcome

controversial material." I doubted this, but we submitted our short article "*Displacement Current*" [4], which goes to the core of classical electromagnetic theory.

The article was published in December 1978 and copies also reached The Atomic Energy Authority (UKAEA) in Culham [5]. This instigated a meeting of UKAEA scientists, who delegated to Dr B.G. Burrows the task of telling Ivall that if *Wireless World* published anything more by Catt it would be boycotted by the scientific community. Nevertheless, Ivall continued to publish Catt articles and the resulting letters, in virtually every issue for ten years.

This was the launch-pad for scientific advance in the twentieth century, the first century when science was controlled by professionals, a century deeply opposed to major scientific advance because of the damage it would do to careers and reputation.

With the retirement of Ivall, *Wireless World* went

back to "normal". Also, Catt was trying (successfully) to get an airing for his new computer invention, "Catt Spiral", which had also been suppressed, so that the later investment of £12m was delayed for more than fifteen years. Because of the struggle to publish on "Catt Spiral", attempts to publish on electromagnetic theory lost top priority. Anyhow, it would have been difficult to get material past the new editor, Ogden, who preferred to publish bizarre material on electromagnetic theory.

The important next stage was the appointment of Eccles, a self-styled disciple of Ivall. He banned Catt from the journal for seven years. The next editor, Reed, however reinstated Catt's writings.

For me, a landmark in this Centenary issue is that it contains the first clear experimental proof that classical electromagnetism is fatally flawed. All our previous publications have been theoretical.
Ivor Catt, UK

Congratulations Electronics World. While pondering your centennial, we were reminded of Linear Technology's celebration of its 30th anniversary a year-and-a-half ago, and the key role of analog in electronics over the past century. Since Linear's founding in 1981, the worldwide analog market has grown from \$2bn annually to \$40bn today. That got us wondering how analog technology has changed over the years.

*– Bob Dobkin, Linear Technology co-founder
(see the interview with him on page 26)*

Electronics and The Evolution

In the 20th century the world underwent a deep transformation thanks to science and technology. Technological progress was supported by the development of electronics. Indeed, 50 years ago technologies were far from being similar to those of today. But although electronics continue to change and evolve, we cannot imagine what engineers of tomorrow may come up with. One thing is for sure and that's behind any innovation lie electronic components, like they have always been.

Take the electron tube for example, the ancestor of the transistor, and look at the transistor today – it is the main part of the processors which are absolutely everywhere.

In the early days vacuum diodes, triodes, tetrodes and pentodes were all active components. The first electron tube was implemented in 1902, followed by the appearance of the triode in 1907, and then the first oscillator was produced containing electronic components in 1913.

The cathode ray tube came in 1914, and in 1919 one implemented the three-electrode tube. In 1948, the first transistor came about, earning a Nobel Prize for the researchers who developed it. In 1954 appeared the first radio based on transistors, and the first thyristor in 1956. The first integrated circuit (IC) was also made in 1956.

In 1960 the LED, and then the MOS transistor in 1962, were followed by the operational amplifier. In 1963 was the triac, and in 1964 it was the family of the TTL logic circuits, manufactured by Texas Instruments. The first electronic computer also made its appearance in 1964.

In 1969, 64-bit memory was developed; in 1970 it was the CCD (Charge Coupled Device); followed by the PROM; ASIC; PLA;

IF; MSI; LSI and then VLSI. In 1972 was the introduction of the 8008 microprocessor and 1974 it was the 6800. In 1990 GSM was quite talked about and 1991 Intel puts its Pentiums on the market. Over the next few years we saw analogue television and radio move to become all-digital.

In 2011 modulated light was transmitted at the speed of 8000Mb/s. Now we ask what's the next step in this evolution of electronic products. For sure they are likely to encompass the intelligence of ecosystems they are in, and become interconnected on a much bigger scale.

Let's see what the future holds.
Hafidh Merchegui, Tunisia

Congratulations on being so, so old!
Barry McKeown, UK

Tony Inskip offers Electronics World his congratulations on reaching its Centenary!
Tony Inskip, Commercial Director of Stadium Group, UK

Happy Birthday! ☺

It's a pleasure to take part. Here are my 'musings' on the past and future of important electronics innovations:

Smartphone, the future

The smartphone of the future will be readily identifiable as part of the same genus as today's devices. It will inevitably incorporate a subset of the technologies, but also surprise us with unimaginable functionalities that lay far beyond mere extrapolation. We'll stop worrying about battery life, storage, computation and even devices.

Smartphones will be a lot more knowledgeable of its owner. Biometric readings such as body temperature, blood pressure, insulin levels, heart rate and all sorts of activity tracking should allow the device to extrapolate a comprehensive picture of our health.

Smartphones can do most of what you can do with a PC. They can connect to the Internet, use social networking sites and

organize our lives. Thus they're fast replacing the PC, which used to be the most irreplaceable piece of technology in our lives.

Electronic valves, the past

Vacuum tubes use heaters to stimulate thermionic emission of electrons from the cathode, but the metal heaters and cathodes eventually burn out.

The electron tube valve was developed by US radio engineer Lee de Forest (1873-1961) and is used to modify electrical signals. Three or more metal electrodes are inset into the tube. By varying the voltage on one of them, called the grid electrode, the current through the valve can be controlled and the valve can act as an amplifier. It is called a valve because it allows a unidirectional flow of electrons.

In the late 1940s, big computers were built with over 10,000 vacuum tubes and occupying over 100 square meters of space. The digital computers using electronic valves (vacuum tubes) are

known as first generation computers.

Each generation of computer has been characterized by a major technological development that fundamentally changed the way computers were built, resulting in increasingly smaller, cheaper, more powerful and more efficient and reliable devices.

The shortcomings of vacuum tubes lead scientists and engineers to think of other ways to make three-terminal devices using electrons in solid materials, like metals and semiconductors.

Semiconductors, usually silicon, deal with the flow of electrons through non-metallic conductors. The point contact transistor was invented in 1947 at Bell Telephone Laboratories, by John Bardeen, William Shockley and Walter Brattain, using a slab of germanium and a plastic triangle wrapped in gold foil. The three men received the 1956 Physics Nobel Prize for their joint invention. From this point began the era of electronics!

Maurizio Di Paolo Emilio, Italy

What a Difference 100 Years Make!

Will 2113 look anything like 2013? I doubt it. Why? Because for one thing 2013 looks nothing like 1913. For example, in 1913 broadcasting, penicillin, air travel and the EU were still in the future. And who would have ever thought I could travel between Germany and Poland as easily as between New York and Connecticut?

I can't predict if our descendants in 2113 will finally have their long-awaited flying cars, but based on current trends here are some rather pessimistic predictions I am willing to bet on:

The world will be a warmer place, with more weather extremes. Efforts to reduce CO2 and other greenhouse gases will have failed; politicians and corporations in 2113 will still be cut from the same short-sighted cloth as today.

A lot of animal species (polar bears come to mind) will survive only in zoos.

The world will be a more dangerous place, as scientists and engineers (that's you, dear reader) invent new weapons and bring old ones within reach of more and more demented individuals or states. The efficiency of killing, by methods now known and still undiscovered, will continue to increase; for proof of this trend in the last century, I need only mention

chemical weapons and the atomic bomb, and earlier, the machine gun.

The world will be a less tolerant place, despite welcome progress in some quarters toward actual equality for those with different skin colour, or beliefs, or sexual preferences, or disabilities. Elsewhere, prejudice, superstition and extremism will still rule, and more people than ever will live in everyday fear.

Hunger? I predict there will be more, as currently-arable land becomes arid (c.f. portions of Essex, UK, recently re-classified from temperate to semi-arid. Essex?!?!) and other land is lost to the rising oceans. And, when the falling output curve crosses the rising mouths-to-feed curve (if it hasn't already), no good can come of the crossing.

Following today's trend, political power will be more under control of corporations, but less visibly, as they fine-tune methods of communication and persuasion in pursuit of power and individual wealth, spam filters notwithstanding. The world will be even more visibly bifurcated between the haves and the have-nots, and using the current American term, 'one-percenters' will be even more in charge, having found ways to largely ignore the messiness of electoral campaigns and the rest of the democratic process. 'Democracy' will exist

in name only, while a growing portion of the world's population will think they have it, but be wrong.

Yes, there will be wonders as yet unimagined, perhaps based on storing huge amounts of information in tiny bits of DNA. Or teleportation, on quantum principles brewing even now. Or medical nano-bots in our bloodstream, chasing bad-guy germs. Or actual human-robot hybrids, in forms and with capabilities, and results, impossible to predict.

If we avoid Armageddon. Because through history nearly every scientific breakthrough was either motivated by, or immediately adopted for, military use. There is no reason for this to change, and every reason to expect it to accelerate. Because in order for there to be change, human nature will have to change, and I'll never bet on that.

Every single breakthrough, every major discovery except possibly penicillin, has been turned to destructive purpose; any constructive purpose always has to wait, and beg for funding.

Or maybe not. Please contradict me, right away; I want to be wrong. There isn't much time; the next century could undo the progress of eons.

Harry Joseph, US

Extra-Terrestrial Relays

The 'Extra-Terrestrial Relays' article by British science writer and former RAF radar technician, Arthur C. Clarke, was published in October 1945 in *Wireless World*, today *Electronics World* magazine. This work was widely credited as the origin of modern satellite communications and, specifically, of the geostationary earth orbit, sometimes also referred to as Clarke's Orbit.

In his work Clarke suggested that three satellites placed in the equatorial plane orbit at an altitude of 36,000km, spaced 120° apart could provide global communications. The altitude is specifically important as here satellites rotate at the same speed as Earth, appearing to be fixed at

the same point above its surface, hence geostationary.

In 1962 Nasa launched Telstar 1, the first same satellite. Telstar 1 lasted only six months, but this paved the way for modern-day communications – there are nearly 900 active satellites in orbit today of which some two-thirds are communications satellites.

Satellite-based wireless communication is one of the most significant steps in history, and it profoundly changed the way we communicate, at the same time making the world a lot smaller.

Arthur C. Clarke's article 'Extra-Terrestrial Relays' was most asked for by the readers to re-print in our Centenary edition, so here it is. *(continues on page 16)*

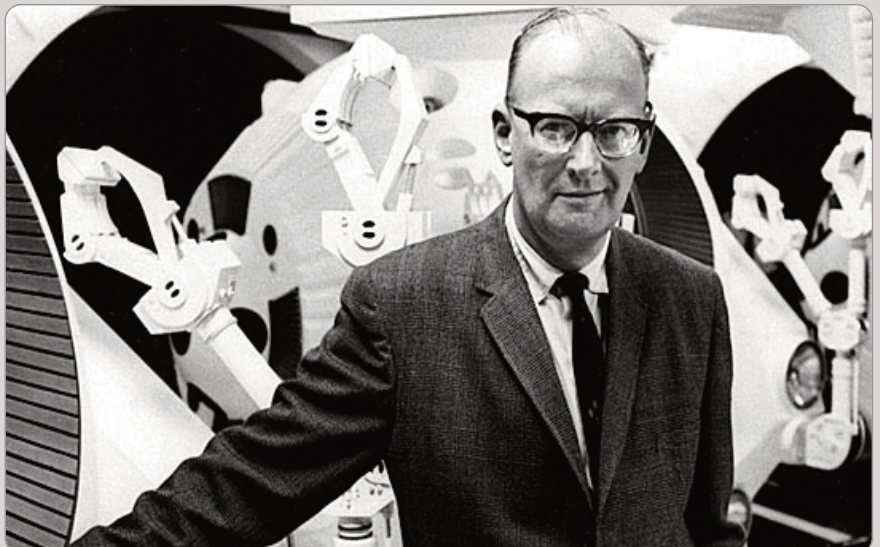
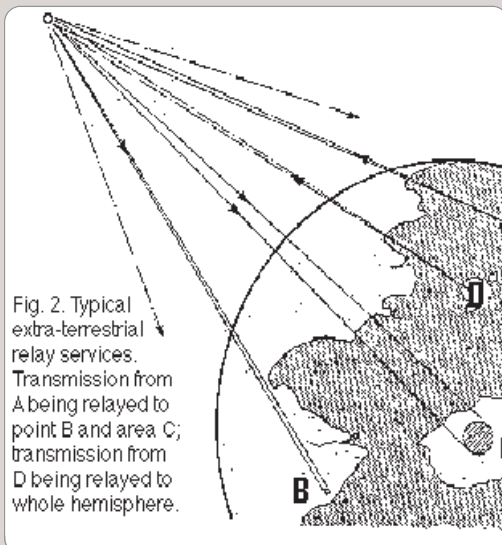
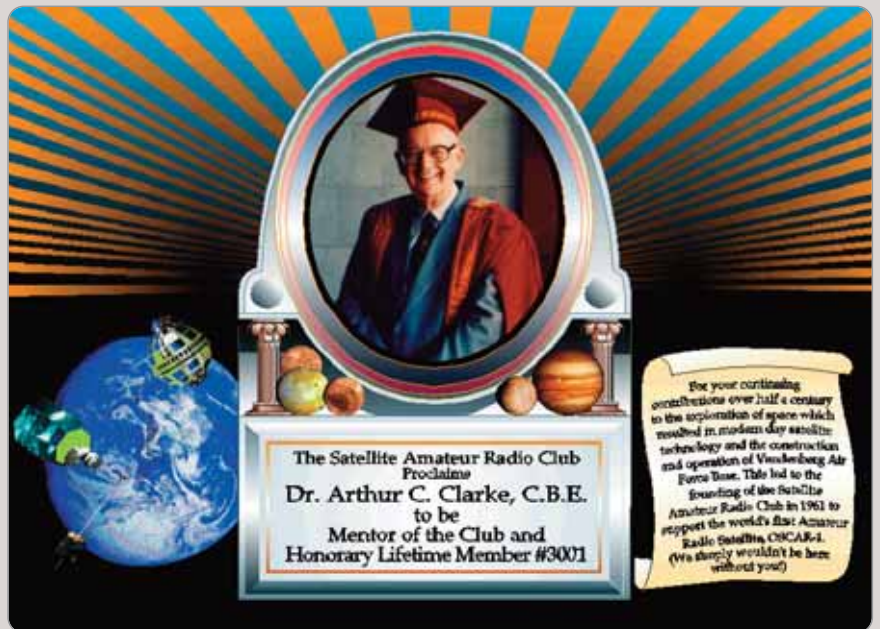
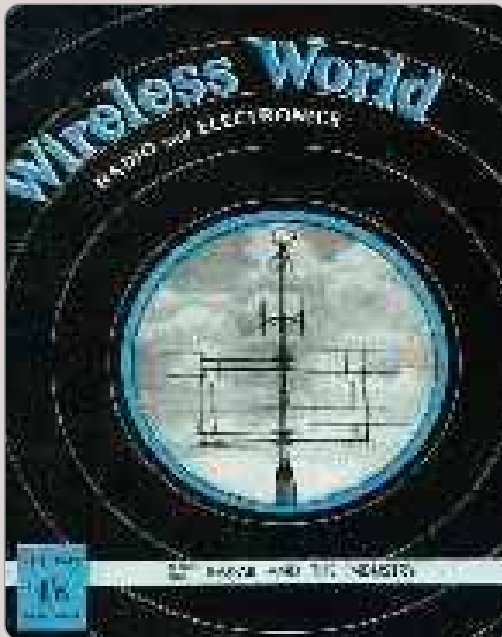

Clockwise from top left: The October 1945 cover of *Wireless World*; Clarke was an honorary lifetime member and mentor of The Satellite Amateur Radio Club; Clarke was a science fiction writer and his short story 'The Sentinel' was the basis for Stanley Kubrick's film '2001: A Space Odyssey'; the diagram of the footprint of a geo-stationary relay, from the 1945 *Wireless World* article

JTAG TECHNOLOGIES®

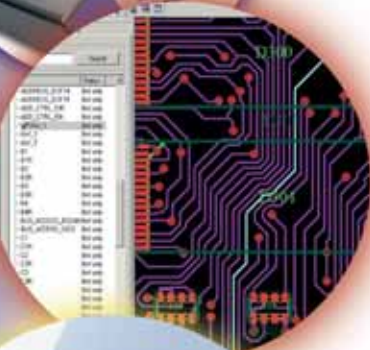

**FREE 60-day
evaluation**

- Find PCB faults under BGAs
- Program PLDs, FPGAs & Flash
- Python™ scripted JTAG routines
- Automated fault coverage examiner
- Visualizer graphical PCB viewers
- LabView, TestStand, .NET integration
- ICT & FPT integration options for Aeroflex, Teradyne, Spea, Agilent, Digitaltest, Seica ..

✉ sales@jtag.co.uk

☎ 01234 831212

www.JTAG.com

..the World's Leading PCB Test & Device Programming Company



RELEC
ELECTRONICS LTD

dc-dc converters 1W to 50W

1W/2W, isolated & unregulated, single & dual output dc-dc converters

Relec Electronics is pleased to introduce the new R2 family of fully integrated fixed input dc-dc converters from Mornsun, these next generation devices offer lower ripple and noise; higher efficiency & larger capacitive loading than the previous design. Typical applications are: digital circuits; low frequency analogue circuits & IGBT driver circuits.

Industry standard pin-out, SIP/DIP packages

Continuous short circuit protection

Efficiency: 1W 81/82%; 2W 89%

Low standby current

Isolation: AS/BS/BD = 1.5kV; ES/FS = 3kV

-40°C to +105°C operating temperature



1W to 50W, 2:1 & 4:1 input, isolated, regulated dc-dc converters

Also upgraded is the entire range of regulated dc-dc converters. All packages 6W and above are now housed in a fully enclosed metal case, providing excellent shielding and low temperature rise. Very competitive pricing and a short 4 week lead time compliment the high performance of these devices.

Wide input ranges (2:1) 9-18, 18-36, 36-75Vdc

Ultra-wide input ranges (4:1) 9-36, 18-75Vdc

Industry standard pin-out

Short circuit protection

Efficiency up to 93%

Low standby current

Isolation: 1.5kV

-40°C to +85°C operating temperature



Relec Electronics Ltd

Tel: +44 1929 555700 Fax: +44 1929 555701

e-mail: sales@relec.co.uk

www.relec.co.uk

Design solutions for design engineers

EXTRA-TERRESTRIAL RELAYS

Can Rocket Stations Give World-wide Radio Coverage?

ALTHOUGH it is possible, by a suitable choice of frequencies and routes, to provide telephony circuits between any two points or regions of the earth for a large part of the time, long-distance communication is greatly hampered by the peculiarities of the ionosphere, and there are even occasions when it may be impossible. A true broadcast service, giving constant field strength at all times over the whole globe would be invaluable, not to say indispensable, in a world society.

Unsatisfactory though the telephony and telegraph position is, that of television is far worse, since ionospheric transmission cannot be employed at all. The service area of a television station, even on a very good site, is only about a hundred miles across. To cover a small country such as Great Britain would require a network of transmitters, connected by coaxial lines, waveguides or VHF relay links. A recent theoretical study¹ has shown that such a system would require repeaters at intervals of fifty miles or less. A system of this kind could provide television coverage, at a very considerable cost, over the whole of a small country. It would be out of the question to provide a large continent with such a service, and only the main centres of population could be included in the network.

The problem is equally serious when an attempt is made to link television services in different parts of the globe. A relay chain several thousand miles long would cost millions, and transoceanic services would still be impossible. Similar considerations apply to the provision of wide-band frequency modulation and other services, such as high-speed facsimile which are by their nature restricted to the ultra-high-frequencies.

Many may consider the solution proposed in this discussion too far-fetched to be taken very seriously. Such an attitude is unreasonable, as everything envisaged here is a

By **ARTHUR C. CLARKE**

logical extension of developments in the last ten years—in particular the perfection of the long-range rocket of which V2 was the prototype. While this article was being written, it was announced that the Germans were considering a similar project, which they believed possible within fifty to a hundred years.

Before proceeding further, it is necessary to discuss briefly certain fundamental laws of rocket propulsion and "astronautics." A rocket which achieved a sufficiently great speed in flight outside the earth's atmosphere would never return. This "orbital" velocity is 8 km per sec. (5 miles per sec), and a rocket which attained it would become an artificial satellite, circling the world for ever with no expenditure of power—a second moon, in fact.

the atmosphere and left to broadcast scientific information back to the earth. A little later, manned rockets will be able to make similar flights with sufficient excess power to break the orbit and return to earth.

There are an infinite number of possible stable orbits, circular and elliptical, in which a rocket would remain if the initial conditions were correct. The velocity of 8 km/sec. applies only to the closest possible orbit, one just outside the atmosphere, and the period of revolution would be about 90 minutes. As the radius of the orbit increases the velocity decreases, since gravity is diminishing and less centrifugal force is needed to balance it. Fig. 1 shows this graphically. The moon, of course, is a particular case and would lie on the curves of Fig. 1 if they were produced. The proposed German space-stations

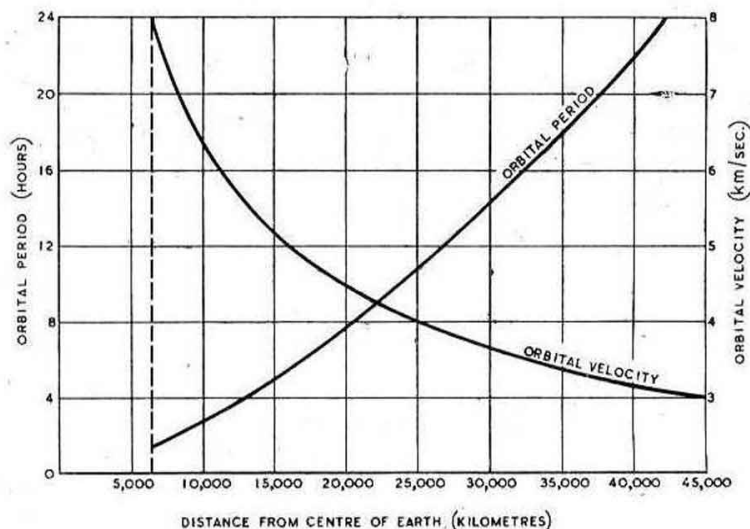

Fig. 1. Variation of orbital period and velocity with distance from the centre of the earth.

The German transatlantic rocket A10 would have reached more than half this velocity.

It will be possible in a few more years to build radio controlled rockets which can be steered into such orbits beyond the limits of

would have a period of about four and a half hours.

It will be observed that one orbit, with a radius of 42,000 km, has a period of exactly 24 hours. A body in such an orbit, if its plane coincided with that of the

earth's equator, would revolve with the earth and would thus be stationary above the same spot on the planet. It would remain fixed in the sky of a whole hemisphere and unlike all other heavenly bodies would neither rise nor set. A body in a smaller orbit would revolve more quickly than the earth and so would rise in the west, as indeed happens with the inner moon of Mars.

Using material ferried up by rockets, it would be possible to construct a "space-station" in such an orbit. The station could be provided with living quarters, laboratories and everything needed for the comfort of its crew, who would be relieved and provisioned by a regular rocket service. This project might be undertaken for purely scientific reasons as it would contribute enormously to our knowledge of astronomy, physics and meteorology. A good deal of literature has already been written on the subject.

Although such an undertaking may seem fantastic, it requires for its

be very small, as direct line of sight transmission would be used. There is the further important point that arrays on the earth, once set up, could remain fixed indefinitely.

Moreover, a transmission received from any point on the hemisphere could be broadcast to the whole of the visible face of the globe, and thus the requirements of all possible services

moon. In the meantime we have visual evidence that frequencies at the optical end of the spectrum pass through with little absorption except at certain frequencies at which resonance effects occur. Medium high frequencies go through the E layer twice to be reflected from the F layer and echoes have been received from meteors in or above the F layer. It

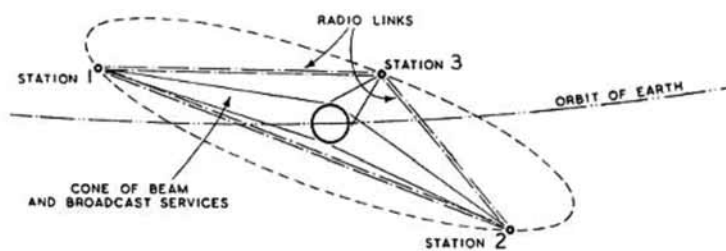

Fig. 3. Three satellite stations would ensure complete coverage of the globe

would be met (Fig. 2).

It may be argued that we have as yet no direct evidence of radio waves passing between the surface of the earth and outer space; all we can say

seems fairly certain that frequencies from, say 50 Mc/s to 100,000 Mc/s could be used without undue absorption in the atmosphere or the ionosphere.

A single station could only provide coverage to half the globe, and for a world service three would be required, though more could be readily utilised. Fig. 3 shows the simplest arrangement. The stations would be arranged approximately equidistantly around the earth, and the following longitudes appear to be suitable:

- 30 E-Africa and Europe.
- 150 E-China and Oceania.
- 90 W-The Americas.

The stations in the chain would be linked by radio or optical beams, and thus any conceivable beam or broadcast service could be provided.

The technical problems involved in the design of such stations are extremely interesting, but only a few can be gone into here. Batteries of parabolic reflectors would be provided, of apertures depending on the frequencies employed. Assuming the use of 3000 Mc/s waves, mirrors about a metre across would beam almost all the power on to the earth. Larger reflectors could be used to illuminate single countries or regions for the more restricted services, with con-

Fig. 2. Typical extra-terrestrial relay services, Transmission from A being relayed to point B and area C; transmission from D being relayed to whole hemisphere.

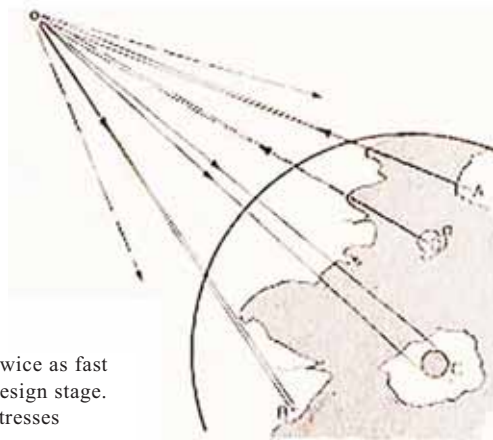

fulfilment rockets only twice as fast as those already in the design stage. Since the gravitational stresses involved in the structure are negligible, only the very lightest materials would be necessary and the station could be as large as required.

Let us now suppose that such a station were built in this orbit. It could be provided with receiving and transmitting equipment (the problem of power will be discussed later) and could act as a repeater to relay transmissions between any two points on the hemisphere beneath, using any frequency which will penetrate the ionosphere. If directive arrays were used, the power requirements would

with certainty is that the shorter wavelengths are not reflected back to the earth. Direct evidence of field strength above the earth's atmosphere could be obtained by V2 rocket technique, and it is to be hoped that someone will do something about this soon as there must be quite a surplus stock somewhere! Alternatively given sufficient transmitting power, we might obtain the necessary evidence by exploring for echoes from the

sequent economy of power. On the higher frequencies it is not difficult to produce beams less than a degree in width, and, as mentioned before, there would be no physical limitations on the size of the mirrors. (From the space station, the disc of the earth would be a little over 17 degrees across). The same mirrors could be used for many different transmissions if precautions were taken to avoid cross modulation.

It is clear from the nature of the system that the power needed will be much less than that required for any other arrangement, since all the energy radiated can be uniformly distributed over the service area, and none is wasted. An approximate estimate of the power required for the broadcast service from a single station can be made as follows:—

The field strength in the equatorial plane of a $\lambda/2$ dipole in free space at a distance of d metres is ⁴

$$e = 6.85 \frac{\sqrt{P}}{d} \text{ volts/metre, where}$$

P is the power radiated in watts.

Taking d as 42,000 km (effectively it would be less), we have $P = 37.6 e^2$ watts. (e now in $\mu\text{V/metre}$.)

If we assume e to be 50 microvolts/metre, which is the F.C.C. standard for frequency modulation, P will be 94 kW. This is the power required for a single dipole, and not an array which would

concentrate all the power on the earth. Such an array would have a gain over a simple dipole of about 80. The power required for the broadcast service would thus be about 1.2 kW.

Ridiculously small though it is, this figure is probably much too generous. Small parabolas about a foot in diameter would be used for receiving at the earth end and would give a very good signal/noise ratio. There would be very little interference, partly because of the frequency used and partly because the mirrors would be pointing towards the sky which could contain no other source of signal. A field strength of 10 microvolts/metre might well be ample, and this would require a transmitter output of only 50 watts.

When it is remembered that these figures relate to the broadcast service, the efficiency of the system will be realised. The point-to-point beam transmissions might need powers of only 10 watts or so. These figures, of course, would need correction for ionospheric and atmospheric absorption, but that would be quite small over most of the band. The slight falling off in field strength due to this cause towards the edge of the service area could be readily corrected by a non-uniform radiator.

The efficiency of the system is strikingly revealed when we consider that the London Television

service required about 3 kW average power for an area less than fifty miles in radius.⁵

A second fundamental problem is the provision of electrical energy to run the large number of transmitters required for the different services. In space beyond the atmosphere, a square metre normal to the solar radiation intercepts 1.35 kW of energy.⁶ Solar engines have already been devised for terrestrial use and are an economic proposition in tropical countries. They employ mirrors to concentrate sunlight on the boiler of a low-pressure steam engine. Although this arrangement is not very efficient it could be made much more so in space where the operating components are in a vacuum, the radiation is intense and continuous, and the low-temperature end of the cycle could be not far from absolute zero. Thermo-electric and photo-electric developments may make it possible to utilise the solar energy more directly.

Though there is no limit to the size of the mirrors that could be built, one fifty metres in radius would intercept over 10,000 kW and at least a quarter of this energy should be available for use.

The station would be in continuous sunlight except for some weeks around the equinoxes, when it would enter the earth's shadow for a few minutes every day. Fig. 4 shows the state of affairs during the eclipse period. For

A project which goes part of the way towards the goal envisaged in this article has been put forward by Westinghouse in collaboration with the Glen L. Martin Co. of America. The radius of coverage would be increased from 50 to 211 miles by beamed radiation from an aircraft flying at a height of 30,000 ft. and equipped with television and FM transmitters.

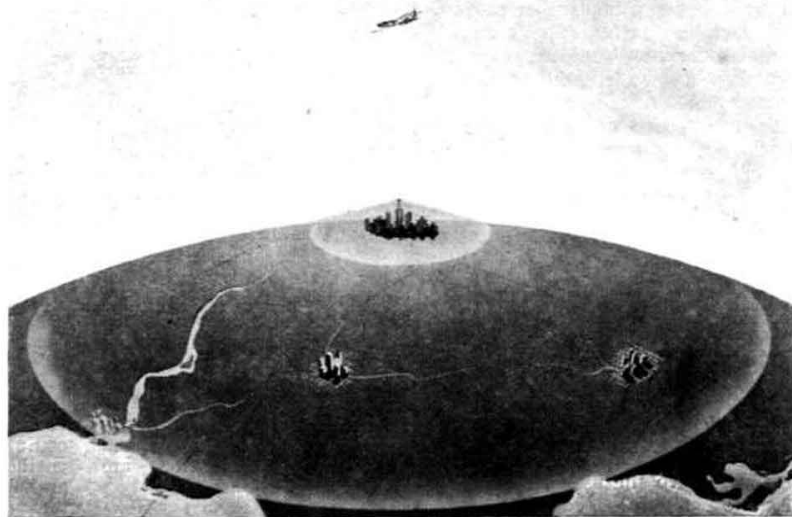

Extra-terrestrial Relays—

this calculation, it is legitimate to consider the earth as fixed and the sun as moving round it. The station would graze the earth's shadow at A, on the last day in February. Every day, as it made its diurnal revolution, it would cut more deeply into the shadow, undergoing its period of maxi-

channels would be available.

(3) The power requirements are extremely small since the efficiency of "illumination" will be almost 100 per cent. Moreover, the cost of the power would be very low.

(4) However great the initial expense, it would only be a fraction of that required for the

ever, owing to its finite acceleration, the rocket loses velocity as a result of gravitational retardation. If its acceleration (assumed constant) is α metres/sec.², then the necessary ratio R_0 is increased to

$$R_0 = R \frac{\alpha + g}{\alpha}$$

For an automatically controlled rocket α would be about $5g$ and so the necessary R would be 37 to 1. Such ratios cannot be realised with a single rocket but can be attained by "step-rockets"², while very much higher ratios (up to 1,000 to 1) can be achieved by the principle of "cellular construction"³.

Epilogue—Atomic Power

The advent of atomic power has at one bound brought space travel half a century nearer. It seems unlikely that we will have to wait as much as twenty years before atomic-powered rockets are developed, and such rockets could reach even the remoter planets with a fantastically small fuel/mass ratio—only a few per cent. The equations developed in the appendix still hold, but v will be increased by a factor of about a thousand.

In view of these facts, it appears hardly worth while to expend much effort on the building of long-distance relay chains. Even the local networks which will soon be under construction may have a working life of only 20-30 years.

References

- ¹ "Radio-Relay Systems," C. W. Hansell. *Proc. I.R.E.*, Vol 33, March, 1945.
- ² "Rockets," Willy Ley. (Viking Press, N.Y.)
- ³ "Das Problem der Befahrung des Weltraums," Hermann Noor-dung.
- ⁴ "Frequency Modulation," A. Hund. (McGraw Hill.)
- ⁵ "London Television Service," MacNamara and Birkinshaw. *J.I.E.E.*, Dec., 1938.
- ⁶ "The Sun," C. G. Abbot. (Appleton-Century Co.)
- ⁷ *Journal of the British Inter-planetary Society*, Jan., 1939.

EUROPEAN FREQUENCY ALLOCATIONS

THE Postmaster-General is understood to be planning an early Conference of interested parties to consider the allocation of frequency channels for the liberated countries of Europe. No detailed information on the scope of the Conference was available up to the time of going to press.

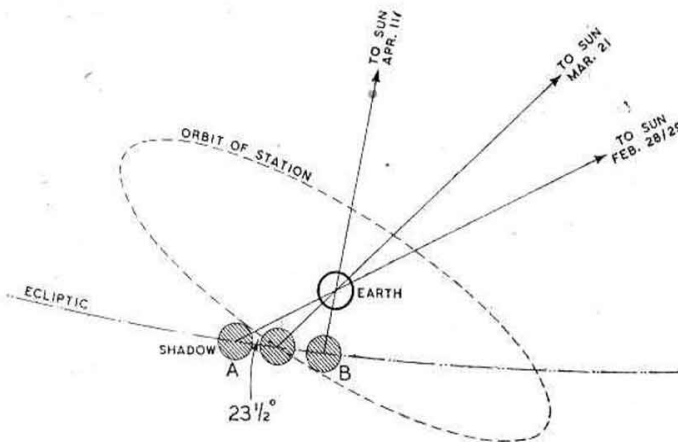

Fig. 4. Solar radiation would be cut off for a short period each day at the equinoxes.

imum eclipse on March 21st. on that day it would only be in darkness for 1 hour 9 minutes. From then onwards the period of eclipse would shorten, and after April 11th (B) the station would be in continuous sunlight again until the same thing happened six months later at the autumn equinox, between September 12th and October 14th. The total period of darkness would be about two days per year, and as the longest period of eclipse would be little more than an hour there should be no difficulty in storing enough power for an uninterrupted service.

Conclusion

Briefly summarised, the advantages of the space station are as follows:—

(1) It is the only way in which true world coverage can be achieved for all possible types of service.

(2) It permits unrestricted use of a band at least 100,000 Mc/s wide, and with the use of beams an almost unlimited number of

world networks replaced, and the running costs would be incomparably less.

Appendix—Rocket Design

The development of rockets sufficiently powerful to reach "orbital" and even "escape" velocity is now only a matter of years. The following figures may be of interest in this connection.

The rocket has to acquire a final velocity of 8 km/sec. Allowing 2 km/sec. for navigational corrections and air resistance loss (this is legitimate as all space-rockets will be launched from very high country) gives a total velocity needed of 10 km/sec. The fundamental equation of rocket motion is²

$$V = v \log_e R$$

where V is the final velocity of the rocket, v the exhaust velocity and R the ratio of initial mass to final mass (payload plus structure). So far v has been about 2-2.5 km/sec for liquid fuel rockets but new designs and fuels will permit of considerably higher figures. (Oxy-hydrogen fuel has a theoretical exhaust velocity of 5.2 km/sec and more powerful combinations are known.) If we assume v to be 3.3 km/sec, R will be 20 to 1. How-

Current Dumping Audio Amplifier

Jan Didden from Linear Audio introduces the *'Current Dumping Audio Amplifier'* article by P. J. Walker, first published in *Wireless World* in December 1975, with a couple of noteworthy letters that followed its publication

It is an almost impossible task to identify the most far-ranging development or invention related to audio in the previous century.

A century ago, we already had a working phonograph invented by Thomas Edison. But if you look at the history of audio it is clear that many related inventions and developments had to appear to get us where we currently are – developments and inventions that were not necessarily aimed at audio recording and reproduction but acted as strong enablers. A short and painfully incomplete list includes: electromagnetism, vacuum tubes, negative feedback, stereo sound, transistors, magnetic tape, communications technology, integrated circuits (ICs), digital computers, digital encoding, RF technology and the Internet.



Peter Walker

Being born almost smack in the middle of the previous century, I grew up with the rapid development of electronics for audio – preamplifiers, power amplifiers, equalizers, crossover filters and so on. One very important yardstick at the time was how transparent the equipment was, mostly expressed in percentage distortion of the signal. Quality was measured by the number of zeros behind the decimal point. We now know that there are many other factors that determine the realistic reproduction of sound

by electronic means, but at the time, the distortion spec was an important metric for manufacturers to differentiate themselves in the marketplace.

Needless to say, many engineering years were spent trying to find that elusive circuit that would produce zero distortion, and hundreds of patents were produced claiming (almost) zero distortion. At the time, *EW's* predecessor publication *Wireless World* was an important battleground where discussions raged in articles and letters to the editor.

In this setting, in 1975, Peter Walker from The Acoustical Manufacturing Company (QUAD) came up with his current dumping approach. He developed a small amplifier with

vanishingly small distortion and used it to drive a speaker, assisted by a hefty output stage called the current dumpers. Using a bridge-type arrangement he managed to compensate for the distortion of the dumpers.

Although Walker confessed that his aim was to do away with the need for adjustment and drift compensation in the class AB audio amplifiers of the time, the possibility of approaching zero distortion caught the imagination.

I was thrilled with this circuit – with its sheer elegance and simplicity which is the hallmark of someone with complete insight in the matter. The battle flared up again, with negative comments from those who clearly didn't understand the circuit; others did a very dense mathematical treatise on the matter to show its shortcomings (which were mainly in the area of manufacturability).

QUAD proceeded to manufacture several products incorporating current dumping; the 405 power-amp was the first. Eventually, the concept did not really catch on. Although theoretically brilliant, a practical implementation for a reasonable-cost layout did not produce significantly better audible results.

This is what first came to mind when thinking about audio developments over the last 100 years. Clearly, it is subjective and very much dependent on what was going on in my formative years and, in the grand scheme of audio things, it is possibly only a speck. But, precisely because audio development has been such an amalgam of (inter)related technologies and developments, it is impossible to point to the most important factor.

We are now witnessing a development that appears to place audio more and more as a supporting act of video. But I will continue to enjoy my CDs, my streaming audio and yes, my vinyl records!



QUAD 405

Current dumping audio amplifier

Output power transistors' non-linearity does not appear in amplifier transfer characteristic

by P. J. Walker

Acoustical Manufacturing Co. Ltd.

If Harold Black did not actually invent negative feedback, he was certainly the first to show a comprehensive understanding of the subject in his famous patent of 1937. Nine years earlier he took out a patent on feed-forward error correction'. Relatively small variations on this nearly 50 year old concept have led to the development of a new type of audio output circuit with attractive properties. The circuit was the subject of a paper presented to the 50th convention of the A.E.S. by M. P. Albinson and the writer earlier this year.

An audio power amplifier is required to produce an output signal that differs from the input signal in magnitude only. It must therefore have occurred to every circuit designer that it should be a simple matter to take a portion of the output, compare it with the input to derive an error signal. It is then only necessary to amplify this error signal and add it to the output in the correct amplitude and phase to cancel completely the distortion of the primary amplifier. Of course, one is left with distortion of the error amplifier but being of very low power this can be made negligibly small without much difficulty.

There is a special appeal in feed forward error correction for transistor power circuits. Because of thermal limitations, the output transistors in the majority of audio amplifiers operate in

class B, in which alternate output transistors handle the negative and positive signal excursions. The output transistors are carefully biased to obtain a reasonably smooth transition from one to the other. If the bias is insufficient there will be a discontinuity in the transfer characteristic. If the bias is too great, there will be a region of overlap when the mutual conductance will be doubled. The curvature of the characteristic near cut-off precludes there being a perfect bias condition and this is further aggravated by the fact that the junction temperature and hence the bias is a varying factor depending upon both the long term and immediate past history of the programme dynamics. A compromise is

selected and overall feedback is applied to obtain an acceptably linear characteristic. Excellent amplifiers have been produced along these lines. Nevertheless, whereas feedback reduces distortion to a small and no doubt negligible amount, feed-forward carries the promise of reducing to zero the distortion of that part of the amplifier over which it is applied. If this is the class B stage, then not only does the distortion itself disappear but all the paraphernalia of quiescent current adjustment and thermal tracking disappears with it.

Feed-forward has only really flourished in areas where stability problems prohibit the use of feedback². In the field of domestic audio amplifiers, it has failed to fire the imagination of all but a few³; presumably due to the extra complications and the undoubted practical problems of adding the error channel to the main 'stiff' output in an elegant manner.

If feed-forward is applied within the loop of a feedback amplifier, its stability advantage is necessarily forfeit. Nevertheless, in return, the need for a separate error amplifier can disappear and mutual loading problems disappear with it. A circuit developed on these lines carries an error component bypassing the main output transistors and so largely releasing them of linearity requirements. This technique has become known as 'current dumping' since this is descriptive of the rather mundane functions they are called upon to perform.

The basis of the new approach is shown in Fig. 1. Amplifier A is a small class A amplifier capable of providing the total required output voltage swing but with limited output current capability. Tr_1 and Tr_2 are current dumping transistors which supply the major part of the load current.

Fig. 1. Basic circuit parameters.

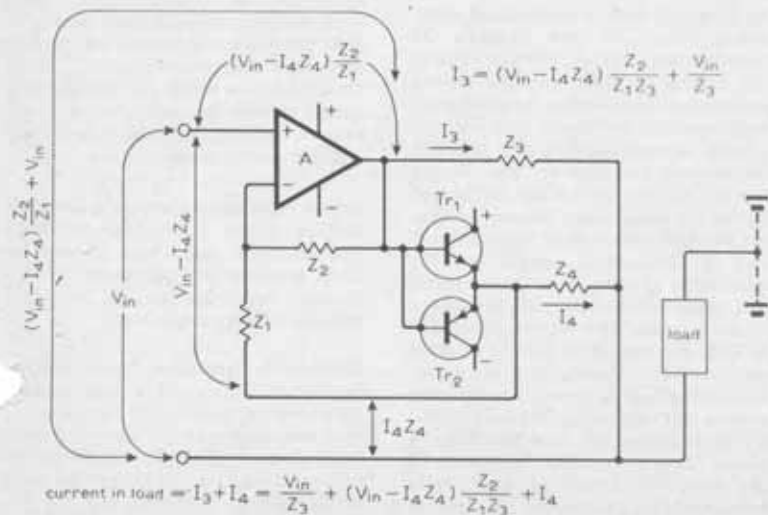

It will help in visualising the operation if the impedances are assumed to be resistors of values $Z_1=1k\ \text{ohm}$; $Z_2=100k\ \text{ohm}$; $Z_3=100\ \text{ohm}$; and $Z_4=1\ \text{ohm}$. In the interest of simplicity we have assumed Z_4 to be negligibly small compared to Z_1 , and for the time being we will assume that the voltage output of amplifier A is completely defined by the external impedances.

With Tr_1 and Tr_2 turned off, amplifier A will deliver current to the load via Z_3 . The current with the values suggested will be 1.01 amps/volt because the second term in the brackets is zero (no I_4 current from the dumpers). When half a volt or thereabouts appears across Z_3 , one or other of the dumpers Tr_1 or Tr_2 will begin to turn on and pass some current I_4 into the load. We have selected resistor values such that Z_4Z_2/Z_1Z_3 is unity so that the second term in the expression for the I_3 current is exactly equal and opposite to I_4 (this second term is the feed-forward error correction component). Currents I_3 and I_4 add in the load so that no matter what the magnitude of I_4 , the overall mutual conductance remains constant. We can say that any distortion in Tr_1 and Tr_2 produces perturbations in the current I_4 and since this causes the exactly equal and opposite perturbations in I_3 , no distortion appears in the load.

Tr_1 and Tr_2 have only one function to perform and that is to dump current into the load sufficiently accurately and sufficiently fast to come to the rescue of the class A amplifier and prevent it from overloading. If this is achieved then the class A amplifier, although it may have considerable gymnastics to perform, will be in complete control of the load current at all times.

Fig. 1 does not look like a practical hi-fi amplifier since its output is constant current and the input is floating relative to the power supply. Nevertheless it is obvious that if the input is returned to the other end of the load all the unique properties of Fig. 1 will still apply though perhaps a little less simple to visualise. This done, we have an amplifier whose output source impedance is Z_4 and Z_3 in parallel.

Two further changes are desirable. A practical amplifier is required to have an internal impedance small compared to the load at audio frequencies and stability requires that the internal loop gain falls with frequency. Both these conditions are met by the use of an inductor for Z_4 , a capacitor for Z_2 and resistors for Z_1 and Z_3 . The requirement for zero distortion from the dumpers is that Z_4Z_2/Z_1Z_3 is unity at all frequencies of interest. This is achieved if $L=RRC$. Fig. 2 shows the circuit with the modifications carried out. (In order to keep the system operating at all frequencies it is necessary for a resistor in series with the inductor to have a conjugate match with a parallel resistor across the capacitor. This has been omitted for simplicity.)

Fig. 2 begins to look very familiar, in fact just like a conventional amplifier with the biasing removed and a small inductor added. Is this really all that is necessary to produce the perfect amplifier? The answer, of course, is no, not quite; the circuit is over-simplified. We have pushed all the problems back

into the class A stage and whilst the distortion would indeed be zero if the class A stage were perfect, this cannot be completely so in practice. We assumed in our analysis that amplifier A was completely controlled by the external impedances, that it had a perfect virtual earth at its input which implied perfect regulation at its output. The effect of departure from this ideal can be assessed by calculation from a deliberate unbalance of the four component bridge, whether this is due to tolerances of any of the components or to inadequate 'stiffness' at the output of amplifier A. With the values shown in Fig. 2, a 5% error in any component value will produce maximum intermodulation products of around $5\ \mu\text{V}$ at 1kHz; maximum possible i.m. of 0.01%, the maximum absolute level of these components being some 140dB below full power. Although frequency dependent, it is clear that balance is by no means critical and standard tolerance fixed components can be used without adjusting facilities.

We have said that the dumpers have

Fig. 2. Basic diagram of principal elements.

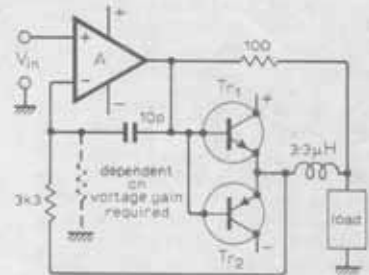
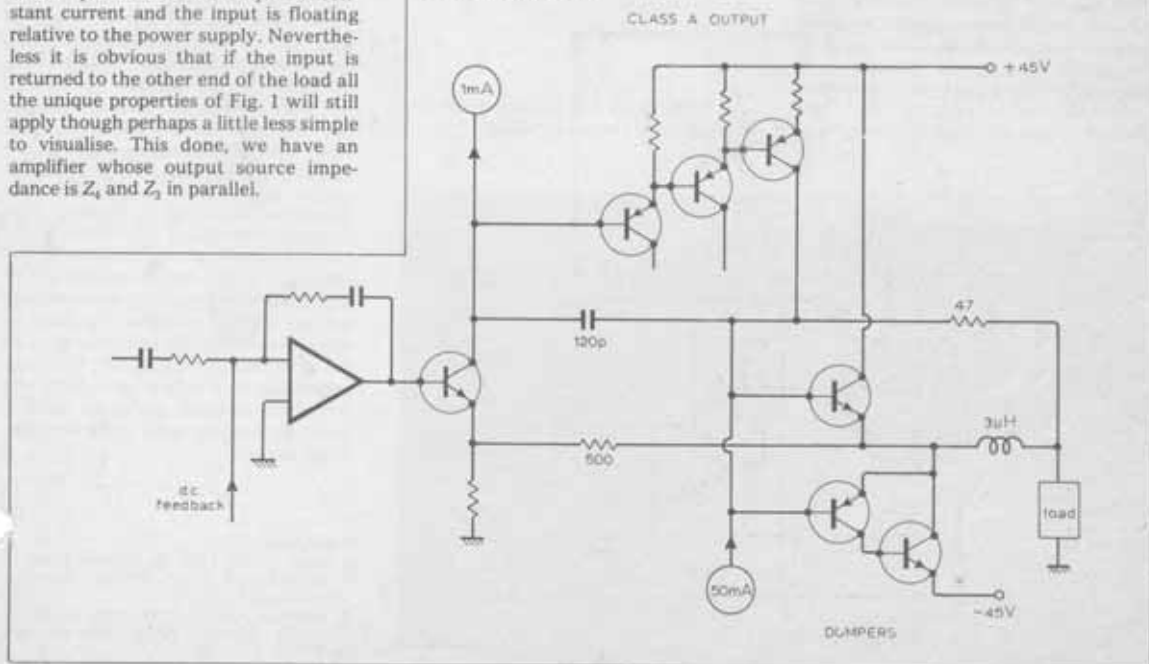
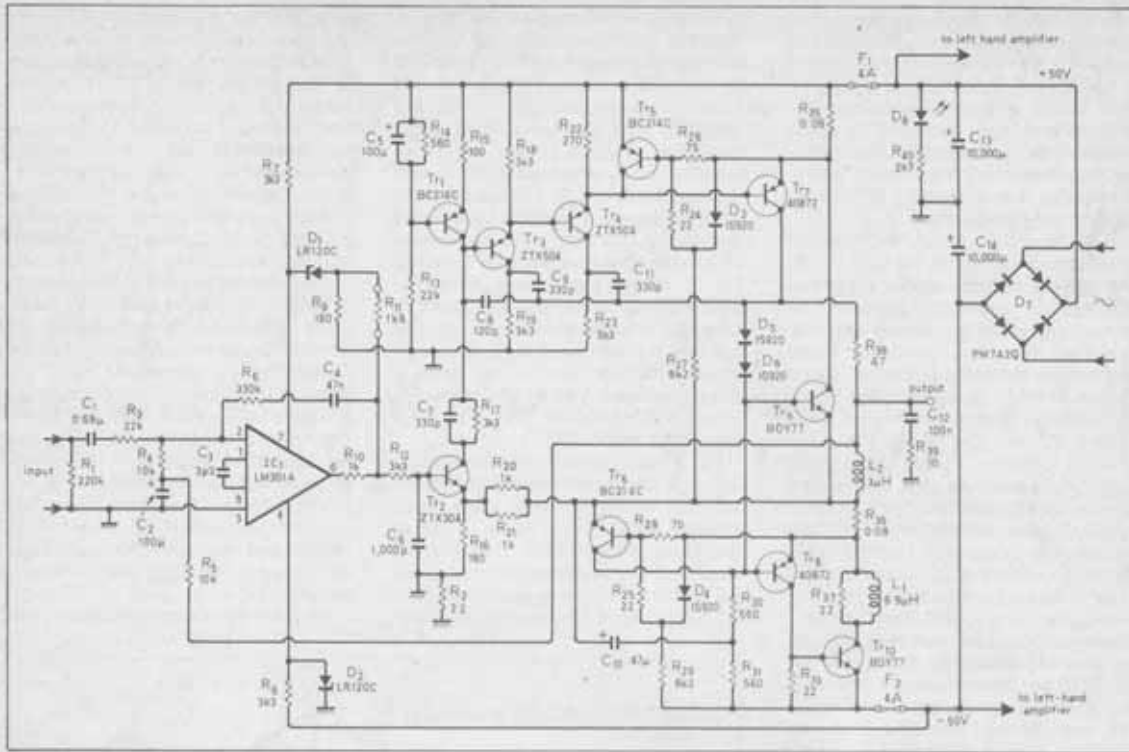

Fig. 3. Simplified diagram showing Class A stage, current dumpers and bridge components.





to be sufficiently fast to come to the rescue of the class A amplifier to prevent its overloading. Clearly they must be sufficiently fast to achieve this over the audio spectrum of the programme. There is, however, nothing whatever to say that they must do so at frequencies outside the audio range provided that steps are taken in the design of the whole amplifier to ensure that any such frequencies that may be present do not embarrass the amplifier performance within the audio range. If the system is properly designed it is possible to use relatively slow devices – inherently more rugged than fast devices – and to show in theory and

Fig. 4. Full circuit diagram. Resistor R_2 is a protective connection provided to ensure earth continuity in the event that Tr_2 and its associated component panel are disconnected from the common earth chassis.

Fig. 5. The Quad 405, a commercial realization of the circuit design.

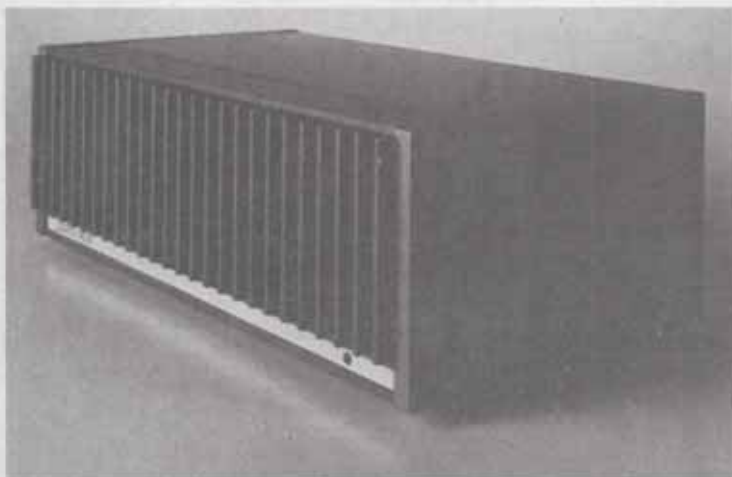

practice that they will never fail to come to the rescue of the low powered amplifier to any programme. If, however, the criteria are thought to be response to step functions, square waves and other factors not relevant to programme, then of course faster dumpers must be used commensurate with the rise times involved.

Fig. 4 shows a commercial amplifier circuit (the Quad 405) developed along these lines, Fig. 3 being a simplified diagram to indicate the relevant areas. The class A amplifier serves also as the driver for the top dumper. To counter this extra burden, the class A amplifier is a triple to give a very effective virtual earth. The mid frequency distortion of this amplifier measures about 0.005%, a region where slight component non-linearities etc. tend to deprive such measurements of any true meaning.

An extremely attractive factor of the technique is the complete absence of adjustments or alignment requirements and no thermal problems. Nothing to set up in manufacture and nothing to go out of adjustment during life. One may expect that after several years there will be far less variation, set to set, than is presently realised with most conventional circuits.

References

1. Black, US Pat. 1,686,792, 9th Oct. 1929.
2. Feedforward error control. *Wireless World*, May 1972, p.232.
3. Sandman, A. M. Reducing amplifier distortion. *Wireless World* October 1974, pp.367-371.

CURRENT DUMPING AMPLIFIER

The recent controversy on the current dumping amplifier (December 1975 issue and subsequent letters) has not come up with any consensus as to whether it is just an elegant method of applying feedback or whether there is an element of feedforward in it. It can be shown quite easily that with an amplifier of finite open loop gain (and consequently finite feedback), the current dump trick achieves much more than feedback alone possibly could. An expression is derived below for the current dump configuration given by Mr Walker and Mr Albinson in *Wireless World* (Dec. 1975), but the amplifier considered has a finite open loop gain and a finite input impedance. With these constraints, and assuming an arbitrary non-linear transfer function for the current dump block, an expression can be derived wherein it can be shown that the error in the current through Z_4 is exactly compensated for by the current through Z_1 provided the conditions given in equation 4 are satisfied.

$$V_{in} = A(V_o - V_i) \quad (1)$$

$$V_i = (Z_2 || Z_3 || Z_m) \left(\frac{V_o}{Z_2} + \frac{V_{in}}{Z_m} + \frac{N(V_o)}{Z_2} \right) \quad (2)$$

$$V_i = (Z_2 || Z_3 || Z_4) \left(\frac{V_o}{Z_2} + \frac{N(V_o)}{Z_4} \right) \quad (3)$$

Simplification yields the combination required to make V_i independent of $N(V_o)$

$$\text{i.e. } \frac{Z_2 Z_3}{Z_2 Z_4} = \frac{1}{1 + \frac{1}{A} \frac{Z_2 || Z_3 || Z_4}{Z_2}} \quad (4)$$

For an infinite gain op-amp, equation 4 reduces to Walker's original form. To confirm this result an amplifier was made with a variable open loop gain (A). This variation in open loop gain was obtained in an elegant manner by connecting a potentiometer across the compensating terminals of the operational amplifier used. The circuit was designed to have minimum distortion for an open loop gain of approximately 52dB, corresponding to 20dB of feedback. Fig. 2 shows the results which confirm that increasing feedback beyond a particular value makes the distortion figure worse. In fact with all the current dump elements removed and the same amount of feedback (20dB), the distortion measured 3.1% against the null reading of 0.4%. This should remove any doubt about the effectiveness of the method, and Mr Walker and Mr Albinson of the Acoustical Manufacturing Company should be congratulated on innovating a most elegant method for removing distortion and for eliminating thermal problems associated with the output stages of high power audio amplifiers. D. M. Divan and V. V. Ghatge, Philips India Ltd.

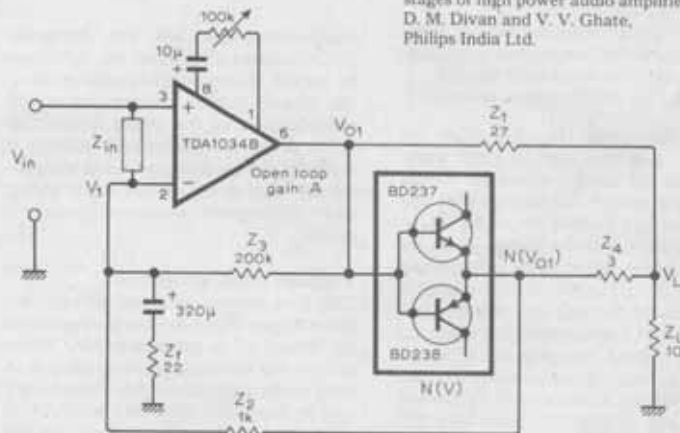

Fig. 1

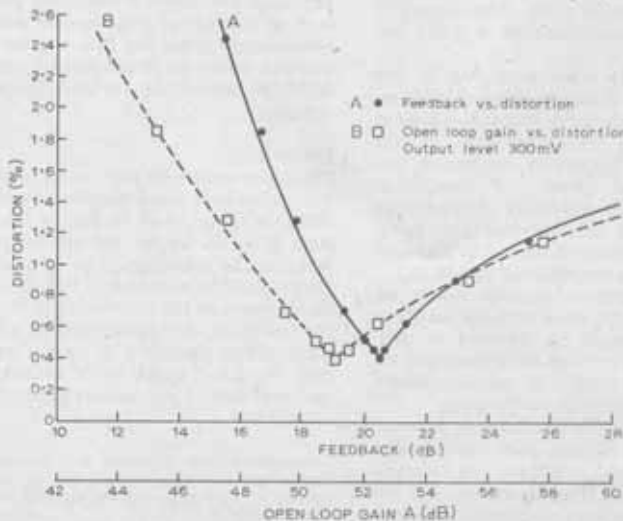

Fig. 2

CURRENT DUMPING AUDIO AMPLIFIER

I have had many enjoyable discussions with P. J. Walker, M. P. Albinson, P. Blomley and R. C. Bowes in the quest for the ideal audio amplifier which would be totally free from audible distortion, have no adjustments of any kind, and be economical and straightforward to manufacture. Numerous fascinating schemes have been considered, and assessing their overall relative virtues has been quite difficult - and indeed, at times, very perplexing.

When the Quad 303 circuit was first evolved, it was evident that the very good linearity of the individual triples, resulting from their internal feedback, was, in a sense, being partially wasted, because the existence of some residual crossover distortion in the transfer of current from one triple to the other necessitated a large amount of overall feedback in addition. A superb performance is, of course, thus obtained, but one was left feeling that if only a circuit could be devised that would sense when both triples were on together and apply extra negative feedback to prevent the gain from increasing, then a more economical design, preferably free from preset adjustments, might be possible. Countless hours were spent scratching around trying to solve this and related problems, and there were moments of elation when it was thought that an answer had been found. But then it turned out that the proposed solution, to work ideally, involved the concept of infinite loop gain - camouflaged, maybe, as a requirement for a zero source impedance at some internal point in the circuit. In other words it turned out merely to be an example of Mr Halliday's "familiar assertion that the distortion can be made negligible by huge amounts of feedback".

Then Peter Blomley's fundamental and excellent new idea came along - a class B amplifier in which both halves of the output stage retained their full mutual conductance throughout the whole audio cycle. This seemed to me at first to be the total answer to the problem of an adjustment-free amplifier with first-class performance, and I did a good deal of very encouraging experimental work leading to simplified circuit designs. It became evident, however, that though the technique is basically absolutely sound, the major practical problem is to ensure that, in the absence of any kind of adjustments or selection of transistors, the quiescent current will fall within reasonable practical limits, albeit quite uncritical ones, without wasting too much output power in high-valued output-stage emitter resistors, or requiring, somewhere in the circuit, transistors having closely-matched V_{be} values at a given current. Circuits using dual transistors, or I.C.s, in the quiescent-current-determining circuitry, were inclined to become undesirably complex, though excellent results were obtainable.

1980

Raychem
CIRCUIT PROTECTION

1990

tyco / Electronics

2000

 **Tyco Electronics**

2010

You've known us for Circuit Protection for almost 40 years.
Even if you weren't always sure about our name.

TE Circuit Protection wishes Electronics World continued success as you enter your second century of informing and empowering the engineering community you serve.

www.circuitprotection.com

© 2013 Tyco Electronics Corporation. All Rights Reserved.
TE (logo), and TE Connectivity are trademarks of the TE Connectivity group of companies and its licensors



When 4 channels are not enough...

A unique 8 channel Mixed Signal Oscilloscope which provides comprehensive measurement and analysis capabilities for embedded, automotive, power and mechatronics applications.

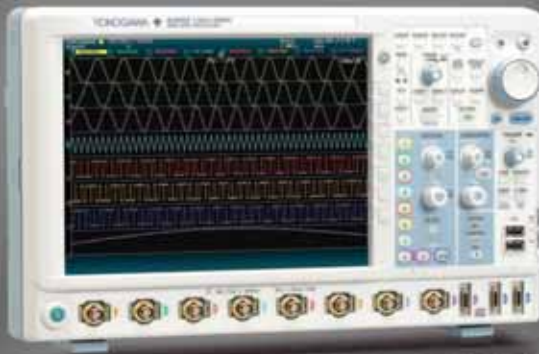

NEW

DLM4000 Series

- 8 analogue channels
- Up to 24 digital inputs
- Up to 500 MHz bandwidth
- Up to 125M points long memory

Solve your complex measurement requirements faster and easier than ever before.



Watch the video at: <http://bit.ly/T1gLUh>
and contact us to see how the DLM4000 can help you.

QUALITY ■ INNOVATION ■ FORESIGHT



YOKOGAWA
YOKOGAWA EUROPE B.V.
Tel.: + 3188 464 1429
tmi@nl.yokogawa.com
<http://tmi.yokogawa.com>

A CENTURY OF ANALOG ELECTRONICS



“We didn’t need to be the biggest, but we wanted to be very profitable”

Bob Dobkin, Co-Founder and Chief Technical Officer of Linear Technology

Bob Dobkin and Bob Swanson founded Linear Technology in 1981. The company known for its high-performance analog products celebrated its 30-year anniversary in 2011. Here, Bob Dobkin gives us his experience of that moment when the company was created, Linear Technology’s advancements, the past life of the analog designer and the future as he sees it.

What inspired you to found the company?

Bob Dobkin: The five original founders of Linear Technology all came from National Semiconductor. The linear group there was doing really well at the time, but despite the fact that we were coming out with great products and selling them, there was little money available to advertise the “linear” products. So, we decided to start our own company as specialists in high-performance analog.

When you founded Linear in 1981, what was your best-case scenario for how the company would do? How did things match up?

Bob Dobkin: We didn’t need to be the biggest, but we wanted to be very profitable. We just wanted to make high-performance analog products. We stuck to this philosophy over the past 30 years, and I think it worked out well. When we were starting, we

Q&A WITH BOB DOBKIN, CO-FOUNDER AND CHIEF TECHNICAL OFFICER OF LINEAR TECHNOLOGY

were thinking five years ahead, and we thought that if we got to \$100 million dollars we would be a great company. History shows we blew through that revenue mark.

What was the secret to your success?

Bob Dobkin: We put in the infrastructure, picked the engineers and built a fab. We made sure that our products worked really well before we released them. Recognizing that there weren’t a lot of analog experts out there – this is still true! – we hired as many as we could afford as well as application engineers to help customers use our products. Today, with thousands of transistors in a product, we still need those application engineers more than ever.

What was Linear’s first major advancement?

Bob Dobkin: I think one of the things we are proudest of is that we broke even very quickly. In fact, we broke even running our own fab and our own wafers at \$15 million dollars a year, which made us independent from requiring further venture capital.

Why did you build your own fab?

Bob Dobkin: We designed the parts, manufactured the silicon and subcontracted the assembly. To make high-performance analog products we needed to have fabs where we could control and tweak the process. The processes we needed, like bipolar transistors, higher voltages, low-noise transistors and thin-film resistors were not available in foundry fabs that make their money running high volumes of digital ICs in CMOS. Now we have two fabs, one in Milpitas, California and one in Camas, Washington.

It’s been said that once an engineer joins Linear, they leave the company only for retirement. Is this true, and if so, why is this the case?

Bob Dobkin: Broadly speaking, there are four reasons. First, we give our engineers a high degree of freedom when it comes to product planning and development. At Linear, the entire new product development process – from product planning, development and production, to sales and marketing – involves the engineers. We encourage our senior designers to meet directly with customers to better understand the challenges they face and to enable them to design next generation products that will satisfy their future needs. Second, our designers have the privilege of working side by side with experienced analog designers who can share analog design techniques not taught in school. Third, we encourage our designers to innovate. Linear develops products that are on the leading edge of performance, so our engineers are challenged to develop the most innovative products. Finally, we compensate our engineers well for their efforts. Overall, I believe Linear is a fulfilling environment for engineers to work.

What remain your biggest challenges?

Bob Dobkin: One of our most limiting resources is good design engineering. So, we produce an effort to make products that are long lasting; ones that sell in moderate volumes for 10, 20, even 30 years. In fact, some of the products I designed in the 1970s are still in volume production today. If you design products that are at the limit achievable in performance, then once you've made it you don't have to do it again!

Any regrets? Any roads you wish you had taken?

Bob Dobkin: I look at what we've achieved: a great reputation both with our customers and financial companies. We did this by doing what we knew how to do very well, making technical advances in the areas where we have a lot of understanding. There are probably a few other areas we could have gone into, but they wouldn't have played to our strengths. I think we did the right thing. No one here has any regrets about our product base, manufacturing, customer support or applications support. We don't look at another company and say "I wish we were like them".

What has surprised you the most about analog technology over the past 30 years?

Bob Dobkin: I think what was most surprising was the influence of digital processing on analog technology. Digital is, and always has been, the driver in semiconductor equipment. If you look at high-performance digital products, there are very fine line-widths and 20-50 masks, yet still they have a defect density that gives high yield. If I take those technologies and transfer them over to analog, it allows me to make products that couldn't have been made thirty years ago. Simply put, complementary bipolar circuits could not have been made without the ability to use 30-50 mask layers. Smaller line-widths help us make converters and high performance power devices in reasonable sizes; our industry would never have supported the revenue to evolve to smaller line widths. We have developed our process around the equipment that was increasingly available because of digital processing, and we made better products because of them.

Do you have any advice for start-ups in this market today?

Bob Dobkin: The analog market is much tougher now than it was, and you need to have plenty of funding. Then, you have to deliver the quality people expect. There has to be some reason for people to buy your product; it has to have an attraction for the customer. If you are going into analog, your focus ought to be high-performance products and you need to be committed to staying the course for several years. If your plan is to go in and be a low-price player in the market, you will have a tough time because there will always be someone selling at lower prices than you.

What do you wish new EEs knew about analog ICs?

Bob Dobkin: One of the greatest challenges we have is finding enough experienced, smart, analog engineers. So, we grow them or we hire them if they are experienced. However, good analog



Electronics World front covers that featured Linear Technology line the walls of the company's headquarters in Milpitas, US

engineers are coveted by a lot of companies because there are not enough of them around. It was actually a bit easier when we first started because analog was not nearly as sophisticated as it is now. We wish there was more analog coursework in the universities' EE (electronic engineering) programs. One of the things that has been dropped from many degree programs is bipolar transistor design.

Any funny stories from your days on the job?

Bob Dobkin: This is a long story that goes back to 1975, during my time at National. Back then digital clocks and calculators were very expensive. Our VP had a digital clock calculator on his desk using chips that National made. We built a little box that changed 60 cycles to 58 and made his clock run slowly, and we installed it in the fuse box. He sent the clock down to the design team to have it fixed. Of course, then it ran slowly again. This went on for nine months. Finally, he finds my box in the fuse box. He did not think it was very funny!

But, this started a series of pranks. In our design area we had a battery-operated wall clock, which started running slowly. We had it replaced, and then it started running fast. We opened it up and saw that someone had messed with the crystal. So, we replaced the crystal. That night it was switched again, so we aimed a motion-activated camera at the clock. We found a note over the lens of the camera: "You aren't going to catch me with that!" Then, the clock started running backward. We switched all the wires, but it still ran backward. We called the engineer who designed the clock, who asserts the clock cannot run backward. We finally determined that someone filed the pole pieces in the clock so that it can only run backwards. In response, we put the numbers up backward. This went on for about a month before we figured out that it was Jim Williams.

How would you sum up the last 30 years at LTC?

Bob Dobkin: It's been fun. The thing I like best is coming out with new and interesting products and watching customers accept them. That's part of being an entrepreneur. All of our engineers are interested in seeing their products do well. We've created an entire company of entrepreneurs, making products and watching them go... and it's going great! ●

ABOUT BOB DOBKIN

Bob Dobkin is a founder and Chief Technical Officer of Linear Technology Corporation. Prior to 1999 he was responsible for all new product development at Linear. Before founding Linear Technology in 1981, Dobkin was Director of Advanced Circuit Development at National Semiconductor for 11 years. He has been closely involved in the development of high performance linear integrated circuits for over 40 years and has generated many industry standard circuits. Dobkin holds over 100 patents pertaining to linear ICs. He attended the Massachusetts Institute of Technology (MIT).

ACCELERATING PRODUCTIVITY, INNOVATION AND DISCOVERY SINCE 1976

NATIONAL INSTRUMENTS HAS SPENT 36 YEARS PIONEERING TECHNOLOGICAL BREAKTHROUGHS THAT MAKE ENGINEERS' LIVES EASIER. SEE WHAT'S COMING NEXT. BY **DR JAMES TRUCHARD**, PRESIDENT, CEO AND CO-FOUNDER OF NATIONAL INSTRUMENTS

Since our founding in 1976, National Instruments's (NI) long-term vision has not changed. Our goal is to make engineers and scientists more productive using whatever commercial technology is available. We watch trends across industries so we can develop products that meet technological demands as soon as they surface. Because of the diversity of our customers, we're in a unique position to stay on top of the latest trends in measurement, sensors, networks, test and more.

The Intersection of Computers and Instrumentation

Like many companies in the high-tech industry, NI has humble beginnings. In the early 1970s, I worked with Jeff Kodosky and Bill Nowlin at The University of Texas at Austin (UT) Applied Research Laboratories. As part of a research project, we used early computer technology to collect and analyse data, but were quickly frustrated by the inefficiency of the systems. We knew there had to be a better way, so we created a product to streamline data collection and improve productivity. In 1976, working in my garage, we founded National Instruments.

"NI has been groundbreaking in instrumentation of all kinds because we recognised the potential of personal computers early on. We knew PCs belonged in the measurement and automation domain," said Kodosky. "From the beginning, we recognised what Moore's Law was making possible. With more computing power at a lower cost, it just made sense to build on top of a PC to get to market faster."

Using a \$10,000 loan, we bought a microcomputer and built a general-purpose interface bus (GPIB) for it. Using this bus, engineers and scientists could connect computers with instrumentation more easily than ever before. In 1977, we officially announced the product and hired the first full-time employee to handle orders, billing and customer inquiries.

In 1980, Jeff, Bill and I quit our jobs at UT to devote ourselves full-time to working at NI, and in 1983 NI developed its first GPIB board to connect instruments to IBM PCs. "The GPIB interface for PCs was a game-changer for NI," says Kodosky. "That got us into broad-based instrument control and really made us understand the trajectory of the PC, which changed the future of the company."

As the company grew, NI started to produce a wider range of GPIB products and invested heavily in R&D. "We started the company with GPIB interfaces that exploited the power of a PC by connecting it to an instrument," says Francis Griffiths, NI's European Vice President. "Because we were at the intersection of computers and instrumentation, we had a unique vantage point that helped us recognise the tremendous potential in blending

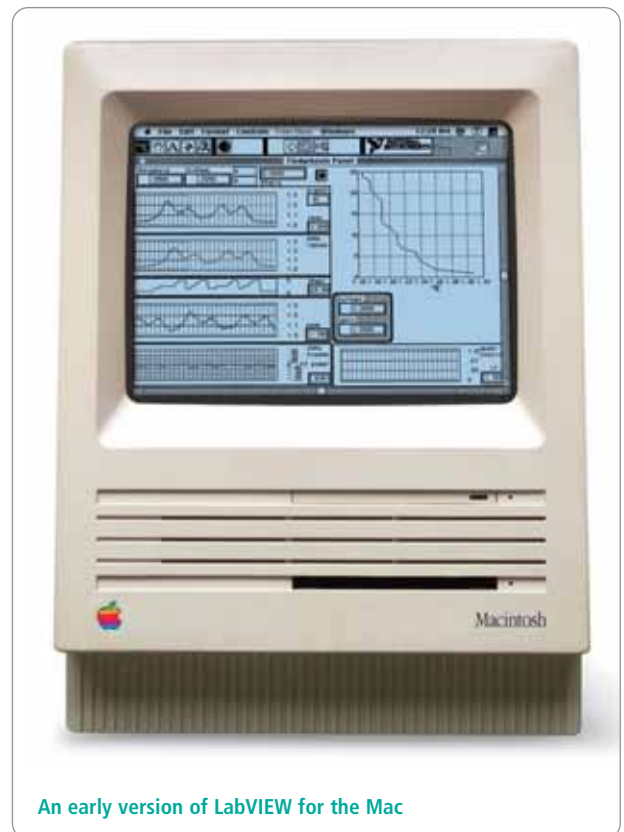

An early version of LabVIEW for the Mac

these technologies together, and so we started down the path of developing products that would meet a wider range of engineers' needs."

A Virtual Vision

In 1984, the company decided to take advantage of the new graphical interfaces on the Macintosh. Jeff began a research initiative with the assistance of student researchers at UT, which led to the creation of NI LabVIEW system design software. The software, officially released in 1986, is used by engineers and scientists to program graphically by wiring icons together instead of typing text-based code.

"We decided to make a tool that was going to be as productive for engineers as the spreadsheet was for accountants," said Kodosky. "I can't believe we had the gall, the boldness to have that vision... I still pinch myself sometimes to make sure I'm not dreaming it's all worked out."

We patented LabVIEW and released it for the Macintosh, Windows-based PCs and Unix workstations. In addition, we released LabWindows for the DOS environment and LabWindows/CVI for ANSI C programmers. We also introduced Signal Conditioning eXtensions for Instrumentation (SCXI) to expand the signal-processing capabilities of the PC.

We've been a pioneer in the virtual instrumentation movement from the beginning. With LabVIEW and our first suite of I/O cards, we provided a concrete vision for what virtual instrumentation could be and how it could change test and measurement for the better.

Texas Meets Tokyo

As the company expanded after the introduction of LabVIEW, we decided to open branch offices around the world to better serve non-US engineers. In 1987 we opened our first international branch in Tokyo. By 2006 there were 21 sales offices in Europe and 12 in the Asia/Pacific region, as well as a multitude of offices in the Americas, Africa and the Middle East. R&D centres are currently located in the US, Germany, India, Romania, China, Canada, Denmark and Malaysia.

"We've expanded tremendously since our founding in 1976," said Eric Starkloff, Vice President of Marketing for Test. "Because we provide tools for our customers and work closely with them to ensure their systems function, we need a presence wherever our customers are. Over the past 20 years, we've invested in branch offices in many countries so we can support our customers wherever they are, in whatever language they speak."

We opened our first international manufacturing plant in 2001 in Debrecen, Hungary. This plant helped diversify the company's manufacturing capabilities, which had been centred at company headquarters in Austin, and allowed for more direct shipping to the company's European customers. In addition, we just finished construction of a manufacturing facility in Penang, Malaysia. These centres are now our second and third largest offices worldwide.

"We've done a good job of maintaining the NI culture no matter where offices are located," said Mike Santori, Business and Technology Fellow at NI. "Our typical employee is smart, driven

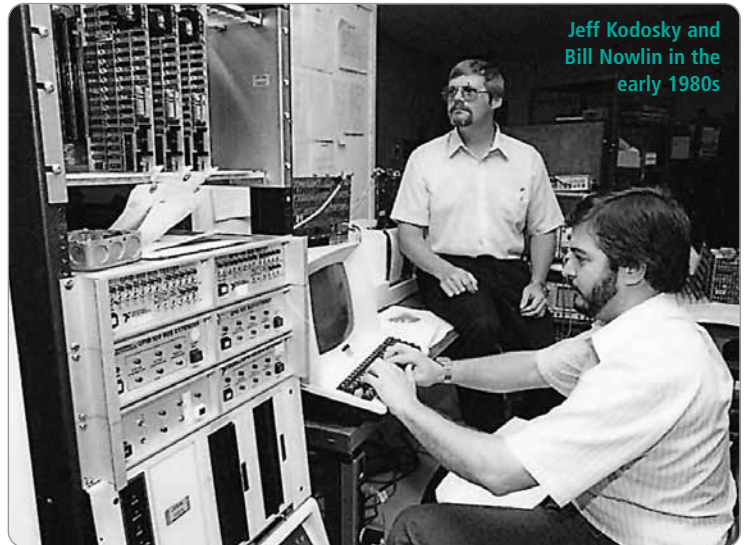

Jeff Kodosky and Bill Nowlin in the early 1980s

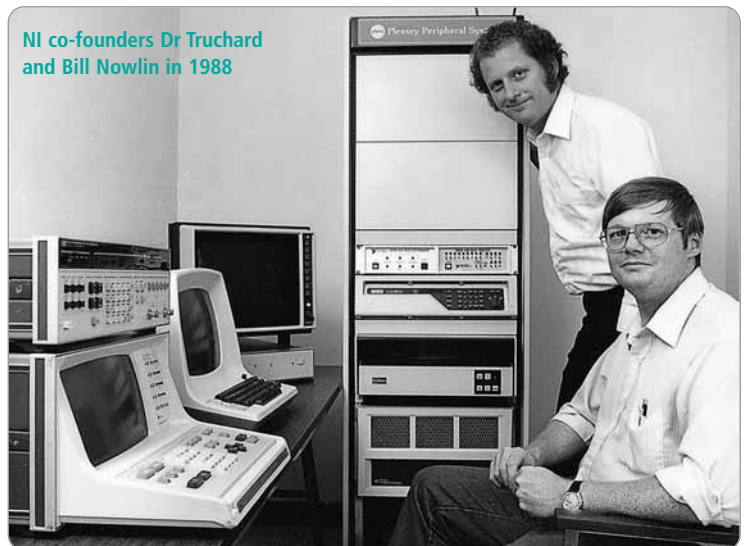

NI co-founders Dr Truchard and Bill Nowlin in 1988

and constantly searching for ways to improve. Those people exist in every culture and we've succeeded in hiring the best and brightest worldwide."

Expanding the NI Platform

Over the next several years NI engineers continued to stretch the boundaries of virtual instrumentation, releasing machine vision software and hardware, which allow cameras to act as sensors, and motion control hardware and software. NI also introduced NI TestStand for test management and PXI, an open industry standard for modular measurement and automation.

"We had done data acquisition and plug-in instrumentation but PXI really started the transition to modular, software-defined instrumentation, which has been a huge area of growth for us," said Starkloff. "The combination of LabVIEW and PXI helps engineers address virtually any engineering challenge."

Today, we are the leading provider of PXI with more than 1,500 products from more than 70 vendors. Engineers around the world have switched to PXI to realise faster test execution times, improved development productivity, faster throughput and increased scalability, which, true to the NI vision, dramatically reduces system complexity and overall system costs.

By the late 1990s, customers began using LabVIEW in



The first version of PXI, released in 1997



NI corporate headquarters in Austin, Texas



NI's manufacturing facility in Penang, Malaysia, opened in autumn 2012

industrial automation applications. With LabVIEW and more advanced NI data acquisition (DAQ) boards, engineers could now replace expensive, fixed-function, vendor-defined instruments with a custom PC-based system that would acquire, analyse and present data with more flexibility at a lower cost.

In 2004, we introduced NI CompactRIO, a reconfigurable embedded control and acquisition system. CompactRIO led us on the path towards using field-programmable gate arrays (FPGAs) as a programmable element of a measurement and automation system.

Seeking Out the Toughest Tech Challenges

Although NI is a billion-dollar company now, with branch offices in 45 countries around the world, our long-term vision and mission have not changed. We're constantly releasing products to meet new market demands. For example, to help engineers and scientists keep up with the mobile explosion over the last few years, we created the LabVIEW Data Dashboard for tablet computers so measurement and control can happen anywhere, at any time. We're always looking for the next tough challenge and we're willing to invest to meet it.

"We aren't just a supplier, we're a trusted technology advisor," said Mike Santori, Business and Technology Fellow at NI. "We use our expertise and resources to ensure that every engineer and scientist in the world can focus on what they were hired to do. They were hired to solve problems, not to worry about the tools needed to do the job."

One of our most recent breakthrough products is the NI PXIe-5644R RF vector signal transceiver, which combines a vector

signal generator and vector signal analyser with a user-programmable FPGA into a single PXI modular instrument. The vector signal transceiver is ideal for testing the latest wireless and cellular standards such as 802.11ac and LTE.

"Essentially, we're redefining how to design and test RF products," said Kodosky. "The LabVIEW to-the-pin capability on our top-line RF hardware opens up a whole new realm of flexibility and capability and I can't wait to see what our customers do with it."

NI has a very different philosophy from other companies in the test and measurement space because we believe our customers are the experts when it comes to their applications. Rather than create turnkey instruments, we give engineers and scientists hardware and software that integrate seamlessly to create the right solution for their unique application.

"Our customers can fully expect that when they're trying to figure out new technologies such as the Cloud or FPGAs, we will give them tools and solutions to help them be successful," said Santori. "We help manage the risk of trying out new technologies. Because we're committed to customer success, we're not going to recommend anything that we don't think will generate a significant return on investment."

Beyond a Billion

What NI does has evolved over time, but the vision remains the same. We started the company in 1976 when we recognised the potential power of connecting a PC to an instrument with GPIB cables. We built software to take advantage of the interactions between the two, then developed hardware based on PC technology, followed by a heavy investment in FPGAs. These developments have all been very influential in the test, measurement and design industries.

"We embrace the term 'graphical system design' because it encompasses our vision for test and measurement, but also our vision for embedded design," said Kodosky. "There's a lot to be done to fill in that vision, so in the coming years we'll be fleshing out our product offerings for all the things we've set the stage for."

Our customers tell us, from across all industries and application areas, that their primary challenge is the increasing complexity of getting devices from design to test. At the same time, the pace of innovation continues to increase, so there is less time to test these complex devices. Engineers need a more seamless migration path from design to test for rapid prototyping, R&D and manufacturing. Our approach has been to create a common platform for everything from prototyping to embedded deployment. We believe a common platform is the best way to address increasing complexity and to cut costs.

"It's really hard to predict the future of technology in this day and age because things change so rapidly. Looking at all the places embedded computers have already shown up, though, we know ultimately that everything we interact with will be 'smart', even things as simple as doorknobs," said Kodosky. "Embedded design and test are already so crucial, so one thing we know for sure is that we'll keep adapting to changing technology."

In the long term, customers can expect us to stay true to our vision. We'll also stay true to the idea of doing more with software that you used to do with hardware. The lines are blurring between test and measurement and the actual prototyping and design of embedded systems. One thing is certain, we'll continue to produce the best tools for engineers to design and test the latest products and technologies. ●

HANDLING INPUT AND OUTPUT ASYMMETRY IN AN MPP BOOSTER CIRCUIT

Michael Frisch, Vincotech GmbH, Unterhaching, Germany,
 Temesi Ernő, Vincotech Kft2060 Bicske, Hungary



The symmetry of split-supply DC voltages with a ground circuit poses a major engineering challenge for transformer-less solar inverters, where fast switching, high frequency and high efficiency, especially, are at a premium. This article describes options for handling input and output asymmetry in an MPP booster circuit. It provides examples of how to connect solar panel strings with varying power levels and loads to NPC (neutral point clamped) and mixed-voltage NPC solar inverters.

HIGH EFFICIENCY, LOW EFFORT

Figure 1 shows a circuit that adjusts the solar panel's MPP (maximum power point) to correct the input's asymmetry while retaining the booster output's NP (neutral point) symmetry. It is actually comprised of two boost circuits, one positive and the other negative. Symmetry is achieved via corrected PWM (pulse width modulation) of the boost circuits.

In the example in figure 2, the input is highly asymmetrical (10kΩ vs. 100kΩ), and the simulated load at the output varies markedly (40Ω vs. 60Ω).

As the result would indicate, it is indeed possible to handle these conditions with such a simple boost circuit. All it takes is the right PWM signal to generate precisely the right software algorithm. The requisite control signals are input voltage (for MPP tracking) and positive and negative DC output voltages, to be adjusted for symmetrical values.

A NOVEL OPTION: THE MULTIPLE INPUT

It is not only possible to control an asymmetrical solar panel and load condition; panels with different power levels and MPP characteristics may even be combined within the boosters.

Pictured in figure 3 is a solution for connecting two low-voltage and one high-voltage string to a three-phase NPC solar inverter. The input stages' design is based on two Vincotech P915

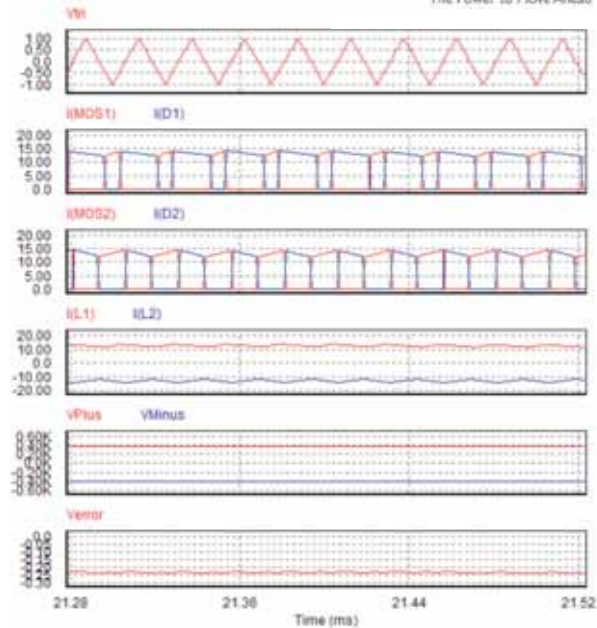

Figure 2

power modules, while the output features three Vincotech P965 mixed components, three-level power modules.

This example uses two lower voltage (125-500V) and one higher voltage (250-1000V) PVs with independent MPP tracking in a three-phase output system with around 24kW. Eliminating the optional GND connection to LV1 and LV2 enables independent MPP tracking for both.

www.vincotech.com

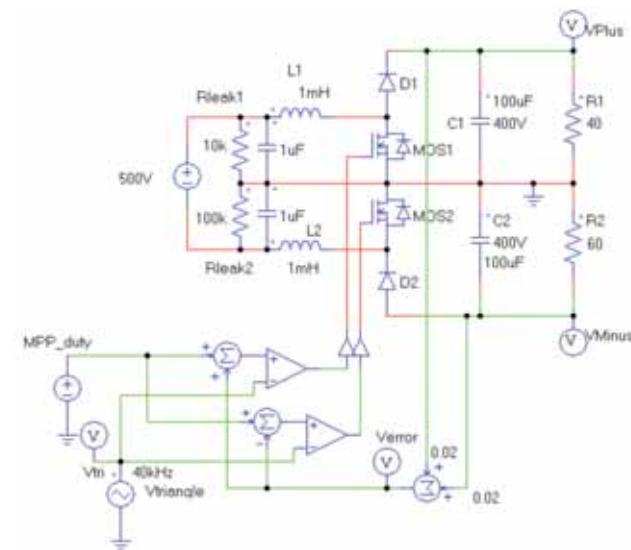

Figure 1

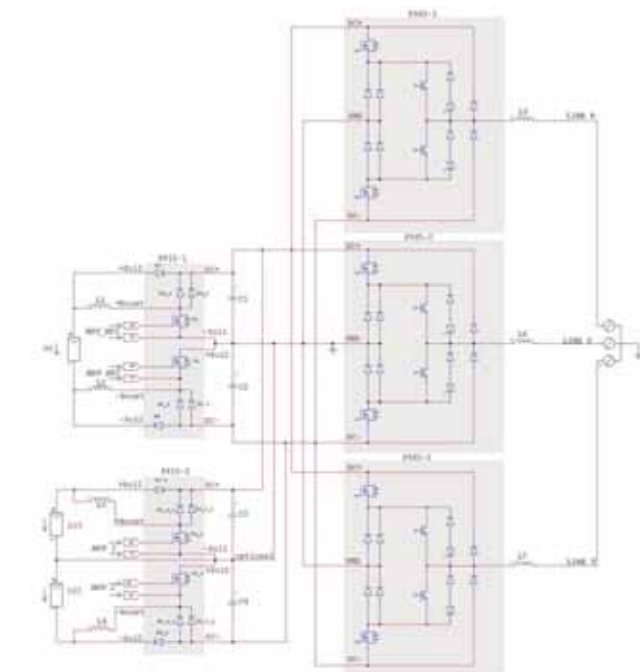

Figure 3

OSCILLOSCOPES EVOLVE TO FIT THEIR TIMES

FROM MECHANICAL TO ANALOG TO DIGITAL, AND FROM 6-BIT TO 12-BIT ARCHITECTURES, OSCILLOSCOPES HAVE STAYED A STEP AHEAD OF THE SIGNALS THEY MEASURE. BY **DAVID MALINIAK**, TECHNICAL MARKETING COMMUNICATIONS SPECIALIST AT TELEDYNE LECROY

There are various ways to describe an electromagnetic waveform, from mathematical equations to increasingly complex representations involving amplitude, phase, time and frequency. All of these methods will give a description of a waveform, albeit one that is highly abstracted and difficult to apply in practical sense.

However, few would dispute that the best way to describe waveforms is with visualization and this is best accomplished using the most ubiquitous piece of electronic test instrumentation ever devised – the oscilloscope.

Early 20th-century attempts at waveform visualization took the form of mechanical methods centering on oscillographs, either drawn on paper – by hand or mechanically – or created using photographic images. Even though these relatively primitive methods were improved over time, they had obvious limitations that left users wanting more improvements, most notably in frequency response.

The quantum leap in oscilloscope technology came with the application of the cathode-ray tube (CRT). Developed in 1897 by

Karl Ferdinand Braun, the CRT was initially a lab apparatus, a physics experiment, with extremely limited application in applied science, due largely to the very high voltages required for its operation. But that changed as a steady stream of technical improvements, including dual-beam tubes that permitted viewing two signals at a time, as well as enhancements in stability and thermionic emitters that greatly reduced the voltage requirements.

Enter the Analog Oscilloscope

By the 1940s, analog oscilloscopes based on CRTs had become prevalent in design and engineering environments (Figure 1). Analog oscilloscopes finally gave users what they'd been looking for: a stable, accurate means of directly displaying signals being probed, giving them unheard-of insight into the behaviour of circuits and the signals they carried. Numerous technical advances kept analog oscilloscopes up to their task well into the digital age, including triggered sweeps, automatic sweep modes, X-Y modes for display of Lissajous patterns for tracking phase differences, and more.

However, analog oscilloscopes carried some limitations of their own. For one thing, it wasn't easy to make measurements on the displayed signals. And even if you could, there was no way to save the results other than writing down numbers or using oscilloscope cameras to take photographs of the display. In addition, the CRTs of the time often exhibited artifacts such as phosphor blooming that resulted in distortion of the waveforms displayed on the tube.

Digital Displaces Analog

By the 1980s, the digital oscilloscope had appeared on the scene, taking a more modern approach to the visualization of waveforms. Rather than directly displaying input waveforms, digital oscilloscopes use high-speed analog-to-digital converters (ADCs) to sample the analog input signal and convert it into digital values of the signal amplitude at each sampling point. The digital amplitude values are subsequently reconstructed to represent the input signal for display.

Digital oscilloscopes represent a major advance over analog oscilloscopes for a number of reasons. For one thing, the conversion of the analog input signal into digital form meant that the waveform could be post-processed and analyzed in a myriad of ways, including sophisticated math functions and quantitative measurements of signal parameters including frequency, amplitude, period, rise/fall times, peak-to-peak voltages, phase differences, slew rates and others. For another, the availability of large amounts of digital memory meant that waveforms could be



Figure 1: Example of an analog oscilloscope: Tektronix's model 485, a 350MHz, dual-channel instrument that debuted in 1973

saved, manipulated, recreated and transferred to other oscilloscopes or test equipment for further analysis.

Digitization of the input signal also meant that a number of new parameters determined a given oscilloscope's capabilities. At the top of the list is bandwidth, which is the frequency range over which the oscilloscope can provide accurate measurement results. Bandwidth is typically expressed in megahertz or gigahertz.

Next is sampling rate; a digital oscilloscope's sampling rate refers to how many samples per second the ADC can acquire and squirrel away in memory. Faster sampling rates mean that the instrument can display, and base its measurements on, finer detail when acquiring high-speed signals.

Record length is another key parameter; this indicates how many waveform points an oscilloscope can acquire for a single waveform record. Record length is related to the depth of memory available on the oscilloscope and is typically expressed in megapoints per channel.

Resolution: The New Banner Spec

Over the decades, all these key parameters that are regarded as an oscilloscope's banner specifications – bandwidth, sampling rate and record length – have steadily improved with each new generation of instruments. However, there is one more key specification that has been consistently overlooked in the digital age: ADC resolution. The ADC's resolution determines its ability to digitize and subsequently reproduce signals on-screen with greater fidelity and detail.

Resolution specifications are touted for many consumer electronics items, such as smartphones, tablets, cameras and television monitors. The effect of greater ADC resolution on an oscilloscope's performance can be likened to the difference between an older-generation television monitor and today's 1080p high-resolution monitors. The effect upon seeing an HDTV for the first time, with its drastic improvement in sharpness, colour and clarity, is startling for many people. The same may be said for the difference between the display on an older digital oscilloscope and one on a high-definition oscilloscope.

The oscilloscope parameter most affected by ADCs with greater resolution is the instrument's vertical precision. The first digital oscilloscopes were equipped with 6-bit ADCs. ADCs have resolution of 2^n bits, which, in the case of the 6-bit ADC translates into 26 bits, or 64 vertical quantization levels. Soon thereafter, oscilloscopes with 8-bit ADCs delivered 28 bits of resolution, which means 256 vertical quantization levels. This represented a 4x improvement in vertical precision, a significant boost at the time. However, for the ensuing 30-odd years, all oscilloscopes have been built around 8-bit ADCs. Performance improvements have mostly come in the form of higher sampling rates, enabling faster real-time signal acquisition. But the vertical resolution and precision have not fundamentally changed.

Working Around 8-Bit ADCs

There are some techniques oscilloscope makers use to increase vertical resolution in instruments with 8-bit ADCs, one being the averaging of multiple acquisitions. By averaging the values of each sampling point from some number of separate acquisitions, uncorrelated noise is averaged out, yielding higher effective

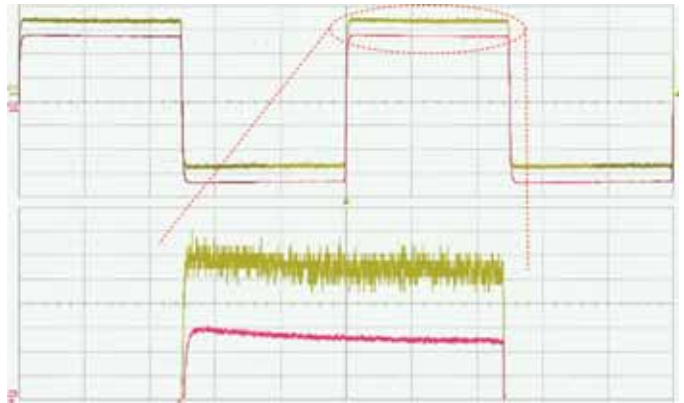

Figure 2: Multiple-acquisition averaging is an attempt at improving vertical precision in software. In this example, a continuous square-wave signal is averaged from the green trace into the cleaner magenta trace seen in the zoom view



Figure 3: Teledyne LeCroy's HDO4054, a 500MHz oscilloscope with a 2.5Gs/s sampling rate and 12.5Mpts/ch of acquisition memory for each of its four channels

vertical precision (Figure 2). This approach has drawbacks, however, the most significant being that it only works with repetitive waveforms, rendering it semi-useful at best. An example of a non-repetitive waveform is a circuit's behaviour at start-up or shut-down, a pseudo-random binary sequence (PRBS) waveform, or a serial-data stream. Any such waveform that is not repetitive in nature, as is, say, a pulse, ramp, or sine waveform, cannot be averaged without producing meaningless results.

A second and more broadly applicable technique for improving vertical precision is referred to variously as enhanced-resolution or high-resolution mode. This technique involves filtering that uses adjacent acquisition samples to mathematically generate a display with higher vertical resolution. Using this technique, an 8-bit oscilloscope can effectively become an 11- or 12-bit oscilloscope. At 12-bit resolution, the instrument delivers 212 bits, or 4096 distinct vertical quantization levels, which in theory is a huge improvement.

Yet, the enhanced-resolution and high-resolution modes have a major drawback as well: a bandwidth trade-off against the extra vertical resolution. The trade-off is fairly complex, with factors including sampling rate, available memory depth and the

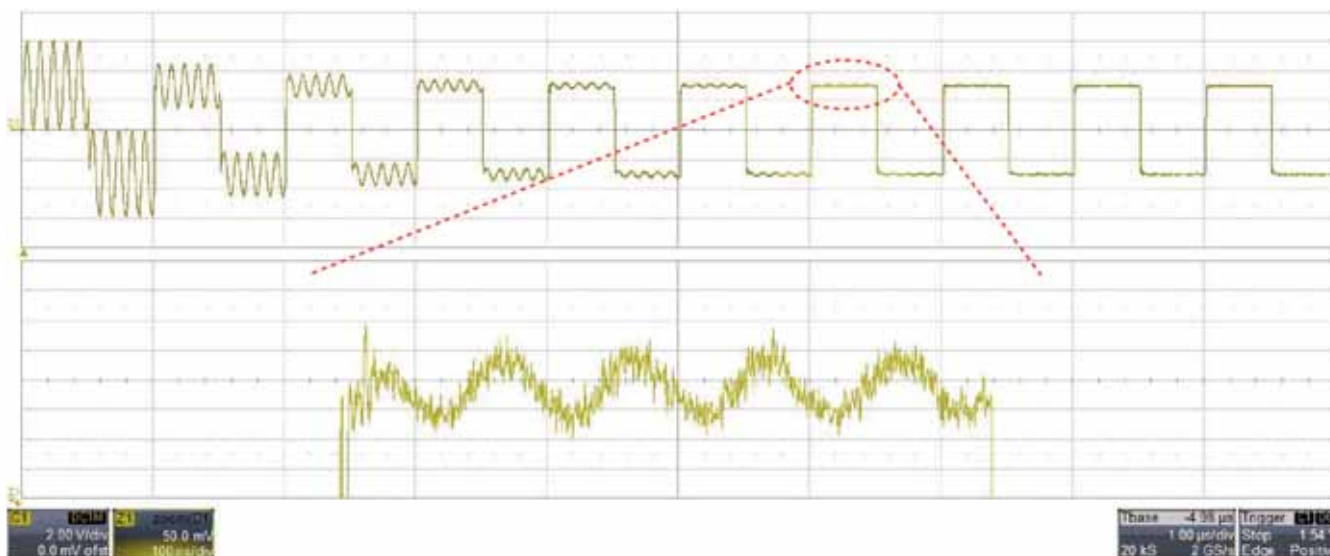

Figure 4: Because HD4096 technology achieves true 12-bit resolution through hardware improvements and not through averaging or filtering, the user no longer needs to average samples by combining multiple acquisitions into a single trace. Compare this HDO screen image with Figure 2, which illustrates the result of multiple-acquisition averaging

horizontal timebase setting. A slower timebase will require more memory to maintain the high sampling rate. Regardless of how much memory is available, a slow enough timebase will eventually cause it to be filled up. At that point, the DSO will automatically reduce the sampling rate to compensate, which in turn reduces the instrument's -3dB bandwidth. Even worse, some DSOs provide readout of bandwidth when employing these modes while others do not.

Moving Up to 12-Bit ADCs

Today's system designs call for oscilloscopes with greater display fidelity and more accurate measurements. For example, the inter-stage timing of high-speed digital circuitry depends heavily on signal edges behaving precisely and predictably. If a transition from low level to high level is too slow, it may disturb proper operation of the subsequent stage in the circuit. Conversely, if rise times are too fast, noise may propagate into adjacent circuitry. An oscilloscope with greater vertical resolution is better equipped to accurately measure such characteristics. Not only that, but it also provides the display resolution users need to gain deeper insight into their circuit's true behaviour.

Rather than attempt to achieve 12-bit resolution, with its concomitant 4096 levels of vertical quantization, using techniques such as averaging or filtering techniques, Teledyne LeCroy has chosen to follow the path of upgrading underlying hardware architecture. In its HD4096 High Definition technology, Teledyne LeCroy combines high-sample-rate 12-bit ADCs with high signal-to-noise ratio amplifiers and low-noise system architecture to deliver 16 times more vertical resolution than any 8-bit DSO.

Benefits of 12-Bit Hardware

HD4096 High Definition technology eliminates the need to resort to averaging of multiple acquisitions or enhanced- or high-resolution modes to achieve higher resolution. This new technology is available in a new family of oscilloscopes called High Definition Oscilloscopes (HDOs). The HDOs achieve high

resolution natively, and the results are manifested in clean, sharp waveforms that present far greater detail (Figure 3). The increased vertical resolution not only results in a better-looking waveform display, but also much more accurate measurements.

Because HD4096 technology achieves true 12-bit resolution through hardware improvements and not through averaging or filtering, users of oscilloscopes such as the HDO may capture and display signals at the instrument's full sampling rate, which in the case of the HDOs is up to 2.5Gsamples/s at bandwidths up to 1GHz. The user no longer needs to average samples by combining multiple acquisitions into a single trace (Figure 4). Similarly, signals do not suffer the distortion that is imposed by removing true noise content along with noise from the oscilloscope itself.

HD4096 technology represents a new approach to oscilloscope design that required rethinking of the instruments' signal acquisition system. The theoretical dynamic range of an 8-bit oscilloscope is approximately 48dB (6dB/bit); for a 12-bit oscilloscope it's approximately 72dB. However, in actual practice, the front-end amplifiers and signal paths in the best 8-bit oscilloscopes only reach a signal-to-noise (SNR) ratio in the range of 35dB to 40dB. Simply swapping out an 8-bit ADC and replacing it with a 12-bit device alone would not change that SNR. By using new, lower-noise technology in the front-end amplifiers and signal paths, HD4096 technology achieves a 15dB improvement in SNR over 8-bit architectures for an SNR of -55dB.

Oscilloscope Evolution

The oscilloscope has evolved throughout the electronic era to reflect the requirements of its users, from the days of probing signals in the audio frequency range to today's high-speed serial communication protocols or on-board buses. As analog technology gave way to digital, oscilloscope technology became more flexible and capable. Today, a new generation of oscilloscopes is prepared for the stiffest challenges they'll face on users' testbenches. ●

HARTING

The HARTING Technology Group is skilled in the fields of electrical, electronic and optical connection, transmission and networking, as well as in manufacturing, mechatronics and software creation. The Group uses these skills to develop customised solutions and products such as connectors for energy and data-transmission applications, including mechanical engineering, rail technology, wind energy plants, factory automation and the telecommunications sector.

The Group, headquartered in Espelkamp, Germany, remains family owned after more than 60 years in business, and despite its European roots has become a global company, with subsidiaries in more than 30 countries worldwide and manufacturing operations in Germany, Switzerland, Romania, the USA and China as well as in the United Kingdom.

HARTING Ltd. has been established in the UK for over 30 years, and has been based in Northampton since 1990. The company currently has over 100 employees in the UK, with turnover currently in excess of £15 million and growth over the past year in excess of 9%. HARTING Ltd. has Investor in People and ISO 14001 accreditation.

HARTING produces a range of high-quality electronic interconnection solutions, the industry-leading Han® heavy-duty connector family and other products for the industrial environment including industrial Ethernet switches and hubs and a range of

network devices for providing distributed power to the network infrastructure.

HARTING's UK manufacturing operation, HARTING Integrated Solutions, manufactures and tests high-speed multi-layer backplanes and integrates them into card frames and enclosures. Cable assemblies from simple ribbon to advanced wiring looms are also offered. In addition to its electronics assembly capabilities, HARTING Integrated Solutions provides expertise in project development, prototyping, test and evaluation.

In recent years, HARTING has evolved from a product-oriented supplier to a provider of total solutions to a number of different industries, including micro-manufactured sensors and RFID systems.

New investment in the UK headquarters includes energy-efficient windows, lighting, gas heating and building management systems to upgrade the working environment for UK-based employees, and more improvements are planned for the future to increase and upgrade the manufacturing facilities on site.

HARTING Limited, Caswell Road, Brackmills Industrial Estate, Northampton, NN4 7PW

**Tel: +44 (0) 1604 827500 • Fax: +44 (0) 1604 706777
Email: gb@harting.com • www.harting.co.uk**

har-flexicon®
Combines flexibility
with stability

Low overall height of 5 mm

Flexible rapid termination
of single wires

Small
1.27 mm pitch

High level of stability due
to SMT fixing

Suitable for fully automatic
assembly and reflow soldering

People | Power | Partnership

HARTING
Pushing Performance

Find all product information here
www.eCatalogue.HARTING.co.uk

Mini I/O pluggable SMD terminal block with rapid termination

Small has never been this splendid. Whether flexible rapid termination of single wires or stable SMT surface assembly - *har-flexicon*® meets the sophisticated requirements made of modern PCB connectors and provides innovative solutions. And, with a pitch size of 1.27 mm, it is setting new standards in the miniaturisation of device connectivity for the transmission of I/O signals. For more information phone +44 (0) 1604 827500 or send an e-mail to gb@HARTING.com

www.HARTING.com/en

HOW IC SOLUTIONS HELPED CARS TO EVOLVE

SABINE JUD, AUTOMOTIVE MARKETING MANAGER AT AUSTRIA-BASED AMS, LOOKS AT THE NEAR-FUTURE TRENDS IN THE AUTOMOTIVE SECTOR

“1

f the automotive industry had advanced as rapidly as the semiconductor industry we'd all be driving a Rolls Royce, it would do half a million miles to the gallon and it would be cheaper to throw away than to park,” – Gordon Moore.

Whilst the development of cars began in 1886, the history of electronics in automobiles started in the 1960s, with the first electronic applications, including intermittent wipers and electronic ignition. Nobody in the sixties could have predicted the number of electric modules increasing so tremendously. Golf 1 in the 70s, for example, did not even have an electronic control unit (ECU)! This has changed dramatically over the last forty years, with the 2006 Golf VI being equipped with 48 ECUs.

Today, the electronics world sees frequent dramatic break-throughs in the automotive field, posing questions about what has driven these developments, which have helped the car evolve into the complex and intelligent status symbol that it is today.

Automotive ICs have evolved in the last decade to include more comfort, entertainment, Internet connectivity, safety and eco-friendly applications. This has meant that the amount of silicon content in vehicles is continuing to grow, with R&D in the semiconductor industry increasing steadily, thanks to the growing complexity of technologies and products.

Safety, telematics and comfort systems all help to drive growth in the automotive field: assistive systems for self-parking, active cruise control, lane departure warning and electronic stability program are just some areas where advancements have been made. The high content of sensors in these applications will also spur the demand for sensor MEMS, in particular for gyroscopes, inertial and pressure sensors.

If we put all these developments together, it's clear that there are three main areas of automobile evolution: environment, safety and comfort.

Environment

Having environmentally-friendly vehicles is important to today's drivers, however when automotive electronics were first developing environmental issues were not on people's radar, as fuel was plentiful, fewer people had cars (it was unusual for families to have more than one car) and the dangers of CO2 emissions were not commonly recognised.

Today, thousands of small ICs help the complex system to become a more environmentally-friendly vehicle. Without developments to the IC, improvements such as the start-stop function, brake energy regeneration and all types of electrification would have never been possible.

Today we see two major directions in developments: the first is electrification of conventional internal combustion engine vehicles for improved efficiency. This is a trend towards micro hybridization based on conventional lead-acid battery technology.

The second direction is toward full hybridization or full electric vehicles. This is quite uncertain due to limitation of the presently available electrical energy storage technologies. Time will show when it will be possible to successfully launch mature electric vehicle solutions to the market.

As semiconductor companies must now contend with the transition to electric cars, the electric and electronic components' share of a vehicle looks set to increase from 40% in a conventional fuel user to 75% in an e-car.

Safety

The second major area of automobile evolution is safety, with drivers and passengers asking for an increased level of protection when they are on the road. This has drastically changed over the last hundred years, with even seatbelts not becoming a mandatory feature in new UK cars until 1967 for front passengers and 1987 for rear passengers.

Drivers today are asking for assistance during driving. We want to be safe and, therefore, value passive-safety applications such as airbags or intelligent seatbelts, as well as asking for active safety features like lane departure warning, collision avoidance systems, traffic sign recognition and so on. All of these major steps in the automobile would have never been possible without the relevant IC developments.

Automotive electronics are constantly evolving, with features such as 3D, rear view or side cameras appearing on the market, which enable drivers to have a better surrounding view and avoid accidents.

Another great example of how ICs and technology help to save lives are laser-based obstacle recognition systems (LIDAR). In the early decades of the automobile nobody would have expected that our cars would ever actively help us to avoid accidents, as they can

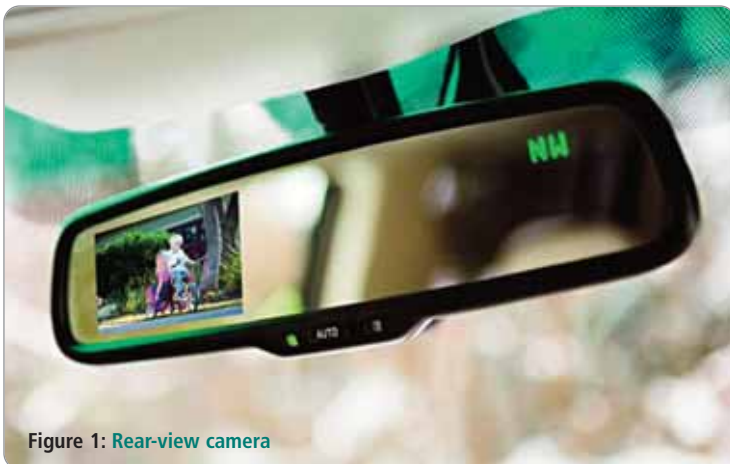

Figure 1: Rear-view camera

do today. LIDAR systems employ an 'invisible' laser in the rear view mirror, illuminating an area about 8 meters in front of the car. The reflected light from obstacles, such as cars or pedestrians in close proximity, is used to measure their distance. If the distance is too small, the system initiates automatic braking. The safety feature is branded by OEMs as "city-safety" or "active city stop". LIDAR systems are among the first active safety features coming into volume production.

Advanced technology platforms ranging from silicon germanium (SiGe) to low-power and high-voltage CMOS, combined with vast design expertise, allow customers to implement demanding safety-critical applications like such crash prevention systems.

Comfort

The third area which has seen substantial developments is comfort. The distances people drive have increased in the last 100 years and so passengers are demanding greater comfort in the vehicle.

Electrification in all comfort applications is impressive and,



Figure 2: LIDAR system in Volvo

therefore, door or seat modules have become increasingly complex. Now we not only want to open and close our doors, we also want them to include a window lift and clamp protection, electric door locks and LEDs. In addition, we are used to remote keyless entry and cars today allow us to electrically adjust our mirrors as well as demist them. All of these applications need reliable and cheap IC solutions.

Semiconductor companies are today striving to design, develop and manufacture chips to meet the changing demands drivers, who expect more safety, more comfort and more fun at the same time, whilst asking for environmentally-friendly cars with lower CO₂ emissions. ●

AMS COMBINES ITS SIGNIFICANT EXPERTISE IN LOW-POWER CONSUMPTION, HIGH ACCURACY AND HIGH VOLTAGE, WITH 30 YEARS OF EXPERIENCE, TO PROVIDE BEST-IN-CLASS INTEGRATED CIRCUITS (ICs) FOR AUTOMOTIVE MARKETS WORLDWIDE.

- In the area of power and battery management, ams provides solutions for current and future applications using a flexible and scalable approach. It focuses on solutions for electric and hybrid car developments, alongside solutions for conventional cars, where it has the unique position to offer high-side and low-side battery management systems for lead-acid cars.
- ams aims to address both the electrification of internal combustion engines and the move toward hybridization and full electric vehicles with existing and future product developments. It offers best-in-class battery sensor products for conventional lead-acid battery management, which support brake energy recovery and idle stop-start automatic electrified vehicle actuators like electric power steering, and demand-controlled engine actuator units like electric water, oil and fuel pumps.
- ams is the first and only provider of solutions for high dynamic-range, highest precision, shunt current measurement, either in positive or negative battery rail, and synchronized voltage measurement. Specific ICs are available to provide power management at very low standby consumption and for connecting the battery sensor to the in-vehicle network (IVN).
- In response to new features such as 3D, rear view or side cameras, which provide a better surrounding view and avoid accidents, ams offers highly efficient power supplies for automotive control units with high-speed CAN interface, perfectly suited to rear view applications.
- Steering is another safety-critical application. To fulfill the toughest automotive requirements, redundancy is a must. For these critical applications ams offers stacked-die of magnetic position sensor ICs, with two independent sensors isolated from each other, in one small package.

AUTOMOTIVE SOLUTIONS FROM AMS



ams headquarters: tradition vs modern technology – a traditional castle combined with modern offices (top) and a state-of-the-art HVC MOS 0.35µm process facility (bottom)

ENGINEERING THE WORLD

HAGOP KOZANIAN, VICE PRESIDENT FOR WORLDWIDE ANALOG MARKETING AT TEXAS INSTRUMENTS (TI), DISCUSSES THE ANALOG, EMBEDDED PROCESSING TECHNOLOGIES THAT DELIVER INNOVATIVE SOLUTIONS WHICH CHANGE THE WORLD

W

e live connected lives in an analog world, and the opportunities for technology to make a significant impact on the way we live, learn and work are more promising today than ever. Innovative engineers create new applications and open new markets every day that improve existing products and, even more exciting, unlock new ways of interacting with the world around us. Semiconductor technology is the backbone of many of these inventions.

Every few years, an undercurrent of technology drives the creation of products that change our lives. In the last couple of decades these have been very visible: mobile phones enabled us to talk to anyone on the move, the Internet opened up the world's knowledge to anyone with a connection and the smartphone movement combined the two. Now we can access

any information, regardless of where we are. There are also countless inventions which spawned from these underlying technologies, such as crowd sourcing, social media, cloud computing and many others.

To spend time predicting the next such wave, in our experience, is a futile exercise. What we have learned over the 83 years of our existence is the importance of focusing on what we're good at doing. At TI, we provide instruments in the form of analog and embedded processing semiconductors for our customers to innovate with. Let's look at some of the innovations we are seeing emerge and let you be the judge of which ones will change our world in the coming decade.

The Pace Of Innovation

Imagine a world where:

- Cars automatically correct mistakes made by the driver, eliminating avoidable accidents.
- Factory production lines don't shut down, because equipment diagnoses itself through smart sensors to avert failure.
- Implanted medical devices don't have to be replaced because they continually charge themselves.
- Medical patients monitor their vital signs with mobile devices and send the data to their doctors.
- Individuals with vision impairment read Braille on an ebook.
- Lives are saved because early-warning sensors provide alerts about natural disasters.
- Smartphones are powered by energy harvested from their environment.
- We can personalize our energy consumption based on a smarter home area network, while utilities track power losses to ensure efficient energy delivery.

Most of these applications are in use today and our customers are actively developing others. Throughout the world innovative analog and embedded processing technologies are increasingly enabling visionary companies to develop smaller, better-performing products that improve automation, safety, convenience and energy efficiency.

Wireless power will help consumers charge their electronic devices more easily. Just as Wi-Fi replaced Ethernet cable for Internet connectivity, wireless power will give users a way to charge their smartphones, tablets, wireless keyboards and other portable electronics in more places – such as automotive consoles, charging pads and even office furniture – without the cables used today.

At TI we have begun installing wireless charging technology in our conference tables so employees, customers and others



Figure 1: The role of the semiconductor supplier is critical to technology advancements

can experience the benefits right here. Looking into the future, a technology that was used in electric toothbrushes in its early days could someday provide wireless charging for electric vehicles.

Connected World

One of today's game-changing innovations is the smart grid. Technology advances are creating once-in-a-generation leaps in efficiency for electric utility companies and giving consumers the information they need to become smarter about how they use energy. The advanced meters at the heart of the smart grid ecosystem deliver near real-time data about consumers' use of power to utility companies and to the consumers themselves. These revolutionary changes are based on huge amounts of data collected by integrated circuits in smart meters and delivered wirelessly to central databases.

The smart or connected home – part of what many call the Internet of Things – is a network of machine-to-machine communication that we believe is still in its infancy. This network includes connected alarm systems that can be monitored through smartphones to notify users when something at home needs attention. It includes connected thermostats that adapt to their surroundings and can be controlled from anywhere in the world using a mobile device. At the core of these innovations are analog and embedded processing technologies, in the form of low-power RF chips, sensor integrated circuits (ICs), analog front-ends, microcontrollers, power devices, interfaces and various semiconductors.

These types of connected technologies are evolving quickly and the pace of innovation increases every year. For example, technologies that currently connect users to their alarm systems and thermostats soon may connect them to sensor nodes throughout their homes, enabling users to turn appliances on or off, receive alerts when power consumption increases, or use cameras to monitor activity on handheld devices. Some of these applications are on the market today and more are on the horizon.

As the connected home and world continue to evolve, engineers developing products for the consumer, industrial, automotive and other markets will invent uses for chips that will continue to help people live smarter and more efficiently.

Consumers Drive Technology Advancements

The driving forces behind these innovations are continuous changes in what consumers care about and the ongoing effort



Figure 2: Robotic arm in a manufacturing environment

by end-equipment manufacturers to achieve greater efficiencies. And the key to success for semiconductor suppliers like TI is to understand and help customers address these trends.

In the industrial segment, for example, companies are creating efficiencies by increasingly automating their manufacturing processes. Improving efficiency enables them to reduce waste and increase output, all while improving the safety of their employees on the factory floor. A programmable robotic arm made even 2% more precise with advanced analog and embedded processing ICs can have a significant impact on a company's success. That robotic arm requires front-end sensor devices, operational amplifiers, communication chips, microcontrollers and power management.

Closer to home, the greatest sources of power consumption within TI wafer fabs are the engines that cool the water used in

Figure 3:
Automotive
infotainment will
be re-defined with
new technologies



manufacturing processes. Compressor motors are the most inefficient part in those engines. So, to improve manufacturing efficiencies by consuming less power and creating less waste, TI now uses variable-drive motors built around analog and embedded processing ICs.

Advancements in the Automotive Market

In the automotive market, manufacturers respond to consumer demands by introducing products to improve safety, save energy and deliver always-on connectivity. Start-stop capability for example, shuts off a gasoline-powered engine when it comes to a stop and then restarts it when the driver presses the accelerator – reducing fuel consumption by at least 10%. That capability sounds simple, but the technology behind it is complex. During hot

The key to success for semiconductor suppliers like TI is to understand and help customers address these trends

summers for example, sensors must tell the air-conditioning compressors to keep blowing cold air. Given that the engine belt is stopped, the compressor motors need to be electrically driven. That capability requires FET technology, motor-control chips, microcontrollers and communication chips.

Shifts in consumer expectations are among the most dynamic changes in today's automotive market. In previous generations young car buyers cared most about the speed and look of their vehicles. Today, however, they want to stay every bit as connected behind the wheel as they are elsewhere. This shift is driving automobile manufacturers to create complex infotainment systems that look and behave like tablet computers.

Adaptive safety is one of the most exciting opportunities in the automotive segment. When we drive at highway speeds today, we trust that other drivers just a few meters away are competent behind the wheel. That's not always the case. Imagine technology-based safety mechanisms that, for example, apply the brakes before an imminent collision. Those types of technologies are available today in some cars, and manufacturers will increasingly include more advanced safety features in the future. ●

MAKING INNOVATIONS REAL

At TI, we have been helping customers engineer the world for nearly 85 years. To us, this means listening to and understanding our customers' needs and then delivering true innovation that in turn enables them to create innovative products for their customers. We are passionate about delivering value-added solutions that make a difference in the world.

Making strategic acquisitions is just one of the important steps we've taken to accomplish that goal. Over the last decade, TI has acquired several large and small companies that have expanded our portfolio to offer complete analog and embedded processing solutions. Each of these decisions has focused on acquiring products and design expertise that deliver differentiation and value for our customers.

TI also has invested in more than 75 advanced analog process technologies that we – and our customers – believe are fundamental to differentiation in the market. These process technologies range from ultra-low-power that enables our customers to compete in the lowest power environments, to high-precision processes that deliver, for example, advanced operational amplifiers that increase the accuracy of robotic arms. There also is increasing interest in higher power process technology for industrial applications, where we are investing considerable efforts.

The purpose of these capabilities is to deliver analog and embedded solutions that help our 90,000 customers create innovative products and accelerate their time to market. One way we do that is to make it as easy as possible for engineers to evaluate our products, simulate their use and complete their design.

This is an exciting time for TI and for the use of technology to improve the world. Our commitment to building a better future is ingrained in everything we do – from the responsible manufacturing of semiconductors to caring for our employees and giving back inside our communities. For more than 80 years, we have been at the forefront of technical innovation, enabling customers to differentiate products with higher integration, faster speeds and lower power. Today, we are engineering the future with advances in industrial, automotive, energy harvesting, power management, cloud computing, safety and security, health technology and more.



Figure 4: Applications enabled by analog technology

MOUSER LEADS WITH “BLUE CHIP” NAMES

M

ouser Electronics, Inc., a top design engineering resource and global distributor for semiconductors and electronic components, is featuring key new suppliers. With the addition of key new lines including leading programmable logic supplier, Altera, and wound components maker, Coilcraft, the distributor continues to complement and strengthen its product range with these additional ‘blue chip’ suppliers.

“We want design Engineers to understand that not only do we have a vast product capability, we also offer the leading names from the Industry,” says Mark Burr-Lonnon, Mouser’s Vice President for EMEA and Asia.

Mouser saw another excellent year in 2012 with record bookings during several months, and according to Burr-Lonnon “is seeing signs of strengthening in the engineering-based market that Mouser serves. In EMEA, bookings at the end for 2012 were up around 30% and billings up by more than 20%. A very healthy book-to-bill ratio of 1.08 also saw us start 2013 very strongly. January and February have shown continued strength with Mouser up a further 22% in Europe, and the business is looking especially in strong in Germany, the UK, France, Italy and Eastern Europe.”

Mouser is known as the ‘design fulfillment’ distributor, enabling the design engineer to access the latest technologies as soon as they become available, providing the widest selection of the newest semiconductors and electronic components from the world’s leading manufacturers. But the latest technologies also require significant

Mark Burr-Lonnon



technical support, so Mouser is constantly broadening the scope of its applications, technologies and market information resource www.mouser.com/applications with white papers, technical and market-driven articles. “Our aim is to make our site as useful as possible,” adds Burr-Lonnon. “But we also want to make it simple. Therefore we have arranged our information resource section under market and technology headings. Most recently, we have added Harsh Environment; there are also sites covering wireless, automotive, alternative energy, audio, smart metering, energy harvesting and more.”

Finally, Mouser believes that design engineers need local support with regional offices that can talk with customers in real time in their own language. The company already has nine locations in Europe and is looking at another addition in late 2013. Concludes Burr-Lonnon: “We really are truly global and aim to service the customer with localized support in local language, time zone and currency.”

With its broad product line and unsurpassed customer service, Mouser caters to design engineers and buyers by delivering What’s Next in advanced technologies. Mouser offers customers 19 global support locations and stocks the world’s widest selection of the latest semiconductors and electronic components for the newest design projects. Mouser Electronics’ website is updated daily and searches more than 10 million products to locate over 3 million orderable part numbers available for easy online purchase. Mouser.com also houses an industry-first interactive catalog, data sheets, supplier-specific reference designs, application notes, technical design information, and engineering tools.

Mouser Electronics
Artisan Building
Suite C, First Floor
Hillbottom Road
High Wycombe
Buckinghamshire
HP12 4HJ
01494-467490
uk@mouser.com
uk.mouser.com



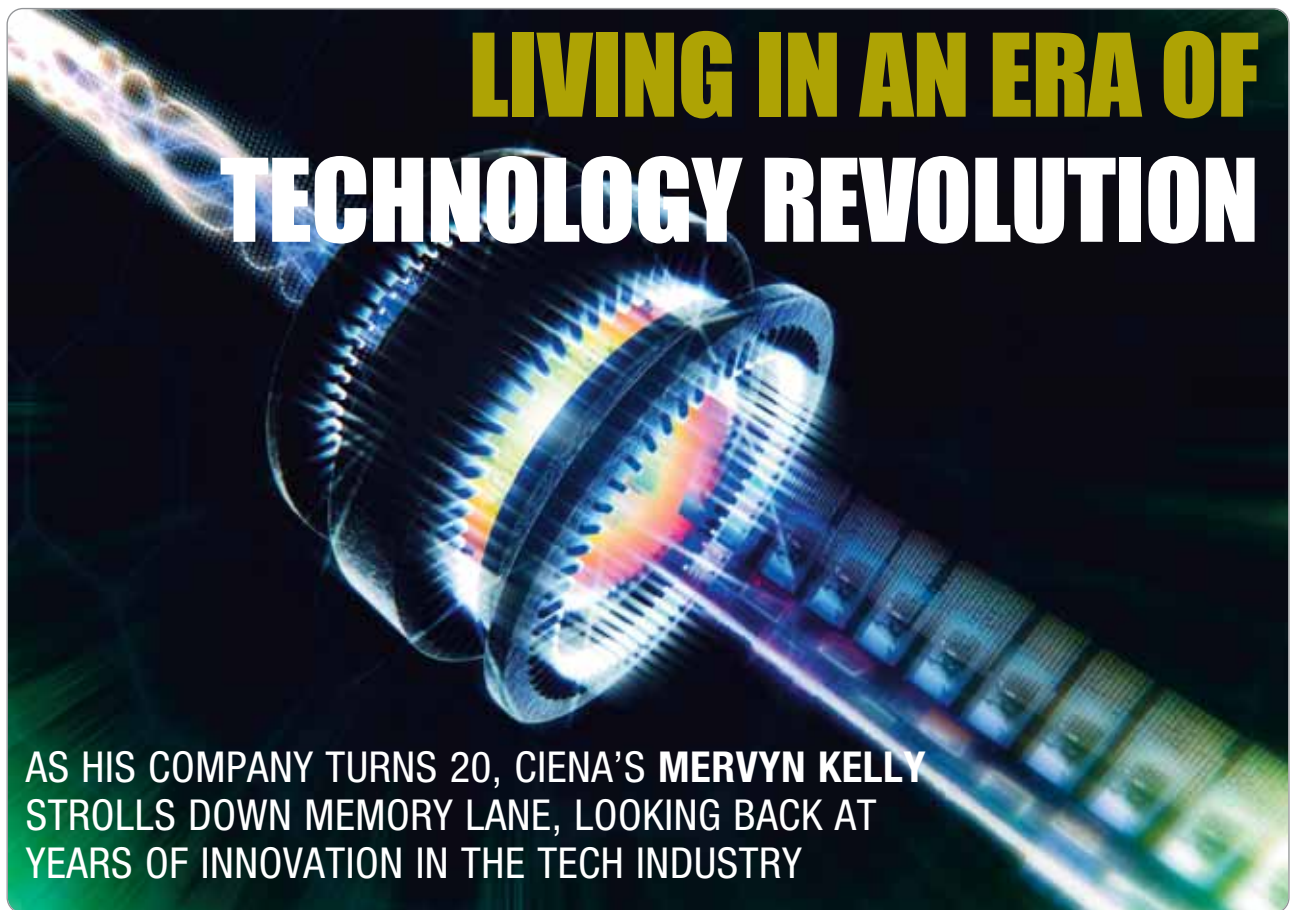

AS HIS COMPANY TURNS 20, CIENA'S MERVYN KELLY STROLLS DOWN MEMORY LANE, LOOKING BACK AT YEARS OF INNOVATION IN THE TECH INDUSTRY

Just a few months ago, network specialist Ciena Corporation celebrated its 20-year anniversary. This memorable event in the company's history made us think about how the technology revolution during that time has changed the way people live and do business – and some of the exciting developments lying ahead.

Remember The Time?

Amazing as it may sound, casting our eyes back just 20 years takes us to a completely different world. One of the things that strike most is that in the early 1990s a typical day at the office still normally included... a trip to the office! Teleworking as we know it today wasn't an option then, as access to information resources or productivity and communication tools were largely limited. Filled with wired phones, fax machines and desktop PCs that worked over a rudimentary network backbone, the office was the axis of business life.

When employees actually did hit the road, they might have used a DTMF dialler to check their voicemail – often from a rotary payphone. Pagers were all the rage and presentations were still typically made on acetate, rather than PowerPoint or the recently popular cloud-based tool Prezi.

On the engineering side, at least in the IT and telecoms industries, things looked decidedly analogue too. Developers and engineers typically had to source years of databooks and information in the corporate library to design their systems, as the centralized data repositories they take for granted today simply did not exist. After all, the majority of knowledge – technical or otherwise – was essentially stored in people's heads in the form of experience, rather than being universally available to those with the acumen to navigate Google and Wikipedia.

Internet – The Driver

If there is a single invention that has over the last 20 years had the most profound impact on the way we live and do business it is undoubtedly the Internet – whose popularisation really started with the mid-1990s uptake of its mass-scale application: Sir Tim Berners-Lee's World Wide Web. Based on hypertext and first web browsing technologies, WWW allowed for digital properties to be linked to one another, in effect creating a virtual web – which has since grown organically to the truly unimaginable size it is today. According to www.worldwidewebsize.com, as of mid-February 2013 the estimated size of Google's index of webpages was roughly 45 billion.

Interestingly, a version of the first www site, which described the World Wide Web project itself, can still be accessed online: <http://bit.ly/13RFF>.

Popularisation of the Internet has had a fundamental impact on the world. It allowed for the creation of new business models, laying foundations for what we today call digital economy. Organisations based entirely on these emerging business models are changing life as we know it, often disrupting and transforming entire industries. These include aviation (airline booking sites), retail and commerce (online department stores, auction sites, price comparison sites), marketing (search-based advertising), or media (on-demand consumption services).

Thanks to the Internet, we have also seen a fundamental shift in access to information. Google, these days known as both a proper noun and a verb, has truly democratised it, putting knowledge on practically any imaginable topic – no matter how obscure – at the fingertips of everyone with access to the web.

Wikipedia, the free online encyclopaedia created by hundreds of thousands of volunteers all over the world, has pushed this

phenomenon even further in its development. Thanks to this, the largest barrier to information today is no longer money, but access to enabling technologies and thirst for knowledge.

The Mobile Piece To The Innovation Jigsaw

One event to remember from 1st July 1991 is the dissolution – after more than four decades of Cold War – of the Warsaw Pact. Another memorable event also took place on that date, and that was the world's first GSM call, made between the Finnish prime minister Harri Holkeri and the mayor of Tampere, Kaarina Suonio.

Mobile telephony was obviously not a novelty, as its first analogue generation had been around since the 1950s, but it was only GSM (or 2G) that triggered true mass-adoption of mobile communications, aided by intensive innovation by handset manufacturers and hardware-subsidy models from service providers. Needless to say, by 2001 the number of worldwide GSM subscribers exceeded 500 million – states the aforementioned Wikipedia.

Since 1991 and the first GSM call, a lot has changed in the mobile communication world itself. Introduction of subsequent generations of mobile telephony – UMTS (3G) in 2001 and LTE (4G) – has enabled countless mobile applications, creating a world where voice is no longer the leading service delivered by telecom operators. Mobile data services, driving applications from SMS through email, web browsing, social networking and mobile video, today take by far the lion's share of service providers' network capacity.

Fundamentally, however, the uptake of mobile telephony and mobile data transformed the world into an always-on place, driving substantial changes to the way we live and do business.

The office is no longer the single place for business people to interact – teleworking has truly taken the stage, enabled by mobile broadband and applications such as teleconferencing and mobile video calls. The implications of this shift are of course mixed; on one hand it has driven workforce productivity, on the other it has led increasingly to occupational burnout, but arguably the socioeconomic benefits of mobility outweigh the costs.

On the engineering side (in the IT and telecoms industries), things looked decidedly analogue

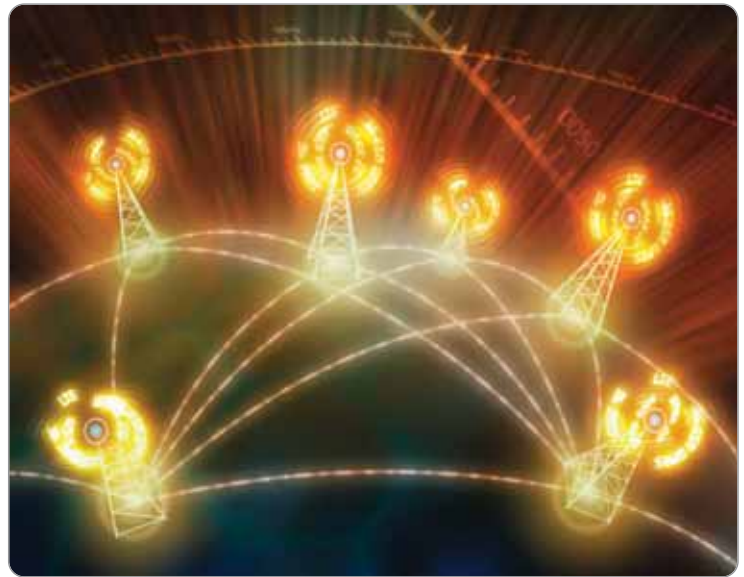

Brave New, Technology-Enabled, World

The results of the technology revolution of the last 20 years are truly awe-inspiring. New applications are popping up like mushrooms, in both business and personal life.

One of them is embodied by the social trend Facebook. It is hard to believe that a mere ten years ago no one had even heard of Facebook; today it is an immense power, driving social interactions worldwide.

“Appification” is another one – the mobile applications ecosystem has truly evolved from a series of productivity widgets to countless applications providing easily accessible and, importantly, instant solutions to many of our everyday needs.

The worlds of science and business have also been revolutionised by the technological progress of the last 20 years. Financial institutions, for instance, have seen the rise of high-frequency algorithmic trading, which has enabled transactions quicker than the blink of an eye, transforming financial markets across the world.

Healthcare has seen the first instances of not only remote operations performed by surgeons thousands of kilometres away, but also the more everyday applications of telemedicine: remote diagnostics and treatment. Both trends are bound to accelerate in the years to come.

Finally, our homes are changing too – the concept of a networked, “smart home” has been talked about for years and will undoubtedly see rapid development in the years to come, from smart metering applications by utility providers to smart fridges using the Internet to automatically re-stock themselves – in a true spirit of the Internet of Things. ●

BIRTHDAY GIRL

Ciena itself has a few claims to fame in the technology revolution of the last 20 years too – inventions which in many cases laid foundations for many front-page stealing developments.

Ciena is widely credited for “splitting light” travelling in fibre optic cables, an early 1990s invention. Pioneering the Dense Wavelength Division Multiplexing (DWDM) technology, Ciena enabled the transport of great volumes of information across communications networks. That move enabled the world to enjoy a plethora of new applications, such as mobile video and HD content, instead of just voice services, which was all a telecom network could transmit back in the day.

With demand for high-bandwidth services increasing at enormous rates, more recently Ciena pioneered coherent optical processing – a technology that laid the foundation for increasing network bandwidth to a staggering 100Gigabit/s per optical channel and beyond, giving an optical fibre the total capacity of a whopping 8.8Terabit/s. In years to come this technology will fuel the next generations of web-based applications, allowing the techno-revolution to continue. After all, the odds are that the Internet will only get faster, with enormously more capacity to store and transmit data, which will create a host of new and unheard of applications with implications for us all.

MAXIM INTEGRATED: CHANGING THE GAME IN ANALOG

By Todd Whitaker, Vice President of Marketing at Maxim Integrated

The electronics market has always been, to one degree or another, about integration. In the early days of the industry, vacuum tubes powered computers that consumed entire floors of buildings. As multiple discrete transistors were “integrated” into the first integrated circuits or ICs, the semiconductor industry was born. By their nature, semiconductors enabled new vistas of possibility as computers became personal, the network became the World Wide Web, and phones gained the “smart” prefix.

Along the way, digital and analog semiconductors experienced divergent evolutionary paths. Digital semiconductor companies pushed the envelope of integration and process technology by creating incredibly powerful processors and expansive memory components. The market for digital semiconductors grew from \$5B in 1984 to \$107B by 1995. After bumping around a bit, it picked up again and reached \$176B by 2010 (source: WSTS).

Analog semiconductors were on a much more methodical track. Revenues for the industry in 1984 were similar to those of the digital industry at \$4B. However, growth rates were slower, rising to a peak of \$31B in 2000 and then slowly climbing to \$42B by 2010.

WHY SUCH DIVERGENT PATHS?

Part of the reason for the difference is in the technology. Advanced digital process technology enabled incredible increases in performance, such that whole new industries were born and rapidly grew up.

Another reason was the approach taken towards integration. Architectural battles were common with the winner in one digital market targeting other digital components on a given system board. As an example, there used to be distinct markets for microprocessors and graphic controller chips. Today, every processor company has integrated graphics, and every graphics company has figured out how to integrate processors and memory.

Analog companies never really played this game. They focused on the four standard analog categories—power, amplifiers, data converters, and interface components. Each made steady, but incremental, progress in their own technical silos. In the pursuit of better performance, analog companies invented new process technologies for use with specific analog technologies. The proliferation of unique process technologies for different types of IP created one more obstacle to playing the integration game.

One can see the divergent evolutionary paths of traditional digital and analog companies as well as the current competitive environment by examining the motherboard of a modern smart phone or tablet computer. Two very large digital chips dominate the board (baseband and applications processors), and there are dozens of smaller analog chips. Besides the traditional manufacturers, new analog companies can be found here as well as digital companies who have crossed over.

CHANGING THE GAME

Maxim is changing the game in analog. Our TINI™ Power SoCs have shown that analog integration is not only possible, but a great advantage to smartphone makers, reducing their board space, component count, and allowing them to add new features into each new generation of smart phone. This tremendous breakthrough enabled us to outgrow our analog peer group by 2x in 2011. Most importantly, this effort has set the stage for future waves of analog integration. Having developed

Total Revenues: Digital vs. Analog Semiconductors

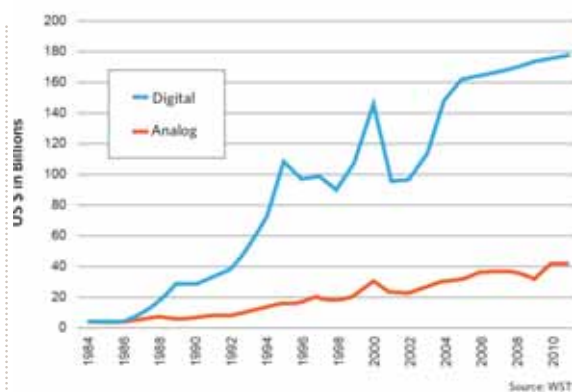

successful, highly integrated, mixed-signal devices for the mobile market, we know this can be done in future projects in other markets.

ANALOG INTEGRATION: NOT JUST FOR SMARTPHONES

Across the Company, we are seeing applications for analog and mixed-signal integration. In 2010, Maxim bought Teridian, a smart meter company, who had integrated all of the basic analog and digital components of a modern smart meter. This business is now one of Maxim’s fastest growing industrial businesses.

In the medical ultrasound market, customers want to shrink the size of ultrasound machines to make them portable. Integration of the components in the transmit-and-receive signal path will enable them to do this. In communications, small cell base stations place a premium on space, and analog companies are integrating the analog front end of these systems. In automotive, demands for integration are driven by space, weight, and reliability. Fewer components mean fewer points of failure. Even core industrial applications, such as motor control, are focused on shrinking their motor control housings from the size of a bread box down to the size of a deck of cards. The integration of Maxim’s security technology, currently the market leader in financial terminals, has applications from automotive to medical systems to factory automation.

BREAKTHROUGH TECHNOLOGIES FUEL OUR FUTURE

To lead the industry in this new age of integration, breakthrough IP is crucial, whether developed in house or through strategic acquisitions. In 2011, Maxim acquired SensorDynamics, thus adding MEMS sensor technology to its portfolio. There are limitless possibilities in the integration of sensors with the analog technology that naturally accompanies them. We also continue to develop other unique blocks of IP in house, which offer the possibility of future integration.

CHALLENGING THE STATUS QUO

In the analog industry, Maxim is playing a new game. This new game is about being better at engaging and understanding the system problems that our customers face. We are separating ourselves from traditional semiconductor manufacturers by our willingness to integrate divergent analog technologies. We are using our IP breadth to do more than just power a processor. We are building analog subsystems. The future of analog is integration and, as Maxim Integrated, we will be leading the charge.

ANALOG INTEGRATION ISN'T FOR EVERYONE



www.maximintegrated.com

FROM GROWING YOUR OWN ORGANS TO SPECTRUM WARS – KEY TRENDS ON THE TECHNOLOGY FRONTIER

MONTY BARLOW, ASSOCIATE DIRECTOR OF WIRELESS AT CAMBRIDGE CONSULTANTS, LOOKS INTO THE FUTURE OF TECHNOLOGY, FROM THE WAY DATA WILL BE USED AND MANAGED, THROUGH FUTURISTIC USE OF IMAGES AND VIDEO, TO THE POTENTIAL SHORTAGE OF RF SPECTRUM

It's clear that technology has advanced at an incredible rate in the last century. Even simple things that we take for granted and which surround us today, like mobile phones and high-definition televisions, were true science fiction a mere 30 years ago. And these are the tip of the iceberg.

As we advance in areas such as embedded microcomputing and signal processing, wireless communication, sensing, biomedicine and genetics, the sophistication and, most importantly, value and opportunity that we can derive from our technological breakthroughs escalates. The ability to interact with the world around us, extracting or injecting information and processing that information in ways that were unachievable before, as well as doing this in a distributed and mobile manner on a worldwide scale, presents new untapped opportunities, ones that far exceed current paradigms to fundamentally change the course and manner of our lives, interactions and experiences in the future. Scary? Perhaps. With these opportunities come significant pressure, responsibility and concern. Will our societal and economic structures keep up with this rate of change?

Here are our thoughts on a few of the macro trends that we see, together with the challenges that we observe in bringing some of these areas to fruition.

Mobility and Connectivity

Mobility is a macro trend that we see across the whole business. Today society has ample expectations of being able to do anything wherever we are. Accessing broadband and Internet services from homes is a given. Expecting to work 'as normal' as we travel on business around the world is the norm. However, the desire to have access to our favourite services beyond these simple applications and confines will continue to intensify. With the exception of the most challenging applications (and of course capacity), wireless technology

solutions exist for most of what we do today. Nevertheless, deployment technology presents challenges.

Devices with mobility still need to be powered. Anyone with a smartphone knows this only too well. For more acute applications, such as body-implanted

Objects like the MP3 player or phone will be able to follow a path from a sleek device today to in-the-ear bud and, eventually, to something implantable and invisible

devices, batteries must be miniaturised and replacement requires surgery. External powering is awkward and, therefore, energy harvesting within the body is attractive. Impressive advances are being made in this area and, when achieved, it'll open up a number of other applications – such as identity/payment/tracking or permanent in-body diagnostics.

In the consumer world, everyday objects like the MP3 player or phone will be able to follow a similar path of the 'clunky item to sleek device' today to in-the-ear bud, and eventually to something implantable and invisible. Adding connection to human intelligence – the combination of self-powering implants and brain interfacing – will be a turning point. Instinctively knowing where you are by receiving external radio signals, accessing external data (from a nearby phone or a remote cloud) or assessing your health data could all be possible.

Blockers To Future Technology Developments

Long-range communications at practical power levels only works at low frequencies, since objects in the way – such as trees – attenuate higher frequency radio transmissions. But bandwidth at low frequencies is in scarce supply, the amount of data you can squeeze out of a chunk of bandwidth is increasing very slowly (perhaps a factor of two in the last 10 years) and the demand for data is increasing quickly.



Figure 1: Clean room



Figure 2: **Hard at work**

Therefore, future radios need to become more intelligent in the way they access spectrum. This results in what are termed ‘cognitive radios’ – radios that switch on, understand what spectrum may be available to them and then access that spectrum on a case-by-case basis.

Inevitably, politics and arguments around what can be switched off/re-used will increase. Much of our communication in the future probably cannot be long range and ad hoc at once. There will be shorter hops from one unit to the next; for example, a wrist watch will communicate with something body-worn which in turn will communicate with in-building hubs.

And could there ever be riots or wars over spectrum? Will an inability to access the future Internet be as bad as, or worse than, days without access to petrol pumps today?

Centralised Management Of Data

Today we are surrounded by devices and systems capable of collecting and generating vast quantities of data. Already, a range of organisations have started collecting this data with good intentions but without clear plans on how it will be used. Even at home, avid photographers or home videographers are hitting the practical and cost limits of storage based on today’s storage density limits.

Businesses often have no or little motivation to share their data for the greater good, as they see this as giving away value. Governments have started to share data, motivated by transparency. However, businesses have learned over time that contributing to open source projects has still realised significant benefits, and we expect to see a similar trend, resulting in more openly shared data.

In the future, we will certainly have to manage data better. Will littering cyberspace with vast quantities of photos and other data be frowned upon or penalised? Will users have to pick up their own data rubbish? How do we prevent ‘data landfill’?

The rate of creation and collection of data is going to outstrip the human brain’s capability to organise, rationalise and generally maintain it:

- Cars will record constant video in the hope of easing insurance claims. Initially this may be discarded if an accident doesn’t occur – but won’t some people start ‘keeping’ their journeys?
- Video will become preferred over stills, with 3D becoming

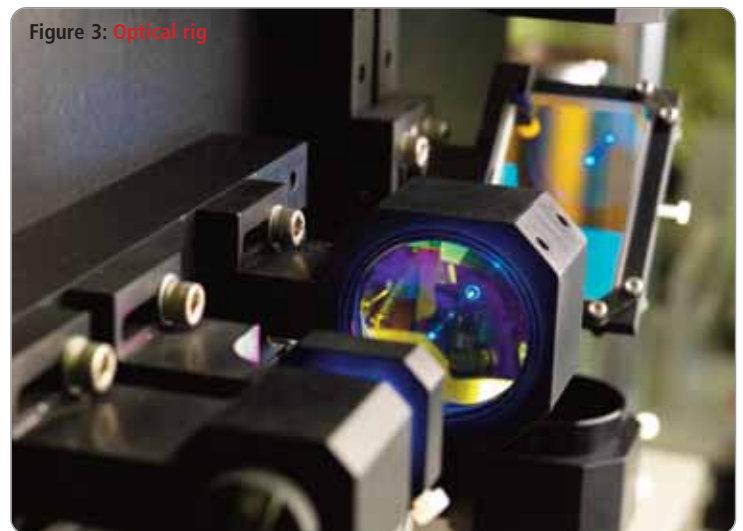

Figure 3: **Optical rig**

preferred over 2D etc.

- Tangled social media interaction will render redundant the concept of a photo album with photos taken by one person and owned by one person.

- ‘Life diary’ pendants.

- Increased metadata – when and where a photo was taken, what mood the photographer was in, heart rate etc.

Consumers will need to use centralised management of data. Services that store, find, display, rationalise and otherwise manipulate user data will become essential. These may well become branded – companies may add their corporate flavour to such services.

Consumers will come to expect their data also to be available everywhere but a number of dangers will be created:

- Pilfering by advertisers, insurers, rivals, employers, government/state.
- An aggregator’s failure may lose its data.
- Data can be altered/deleted by miscreants.
- Reliance on unreliable/overburdened communications links.
- Increased complexity in managing our everyday lives.

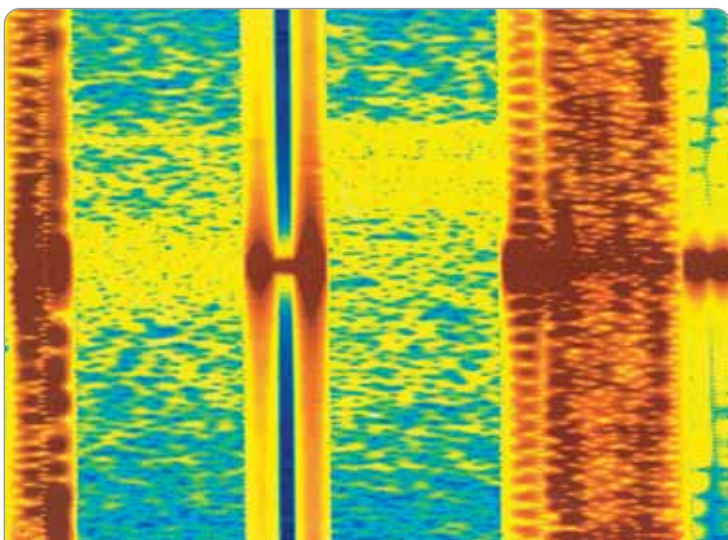

Figure 4: Signal process

Boundaries Are Becoming Blurred

Today, there are already many examples of in-body and on-body electronics. Applications range from consumer products, through safety/security equipment, to medical/wellness devices. Many use short-range communications to connect to the user and the outside world. At the same time, significant advances are being made in sensing and actuation technologies that allow us to interact with the real world in far more sophisticated ways. Over time, we see the boundary between electronics – as we see it today – and the organic world blurring as we find better and more efficient ways to interact technically with the world around us. In addition, implanted electronics will continue to be a growth market, driven by benefits from localised monitoring and treatment.

Technology And The Body

Technologies for surgical procedures will continue to become more sophisticated. Opportunities for procedures to become less invasive will extend. Further, the ways in which we administer treatments and doses will become more effective. Today, ‘closed loop’ dosing methods in which drug delivery performance is measured and optimised will be enhanced further, with real-time monitoring of conditions and compliance management – with this data, in turn, being sent to

Could there ever be riots or wars over spectrum? Will an inability to access the future Internet be as bad as, or worse than, days without access to petrol pumps today?

and analysed by the relevant healthcare provider.

With the advent of 3D printing now reaching prosumers, could this spell the end of traditional manufacturing? For example, could the same trend be seen in pharmaceuticals in the future? Locally manufactured treatments (in the home, pharmacy or at the GP) would offer a number of benefits:

- Tailoring of drugs to individual’s chemistry/biology.
 - Reduction in the (wide-spread) counterfeiting of drugs such as anti-malarials.
 - Reducing stock management burden on pharmacies (sell-by dates, threat of theft etc).
 - Rapid response to epidemics or biological/chemical terrorist attacks.
- However, a whole set of possibilities for crime would emerge, such as:
- Subverting drug creation (equivalent of a computer ‘Trojan Horse’).
 - Creation of illegal narcotics.
 - Murder achieved by corrupting the manufacture of a local drug.

In the same way that silicon chips and software created a virtuous circle of rapid progress (with chip design software running on the best chips from the previous generation), synthetic biology may do the same for new fields; new organisms created entirely within a lab may be used to push the boundaries of what can we build. This may accelerate the arrival of a future of designer bacteria, enhanced organs and genetically-targeted weapons.

Social Tagging

Today there is a fairly clear distinction for most people between online and real life – good deeds done for an elderly neighbour or a fellow worker are likely to be unrelated to good deeds done helping someone on a forum. Employers and other organisations are likely to seek references from these.

This distinction is bound to blur in the future. Whether desirable or not, there will be increasing evidence of how we lead our lives available to those wishing to mine the data – from social networking, phones, surveillance cameras, payments etc. This suggests the possibility of attempting to judge someone’s ‘value’: have they been sufficiently charitable, selfless and environmentally-minded to deserve a promotion (or even a priority parking space at the supermarket)? What will be the high-tech equivalent of attending a charity lunch?

Into the Future?

No-one can truly claim to be able to see into the future. But painting a picture of what may be in store – and simulating future scenarios – allows our imagination, innovation and expertise to constantly redraw the boundaries of the impossible. ●

SEEING THE FUTURE

In April 1911 the Marconi Company went into print with *The Marconigraph*, which after two years was renamed *The Wireless World*, a century ago. The forward to this edition stated: “Seventeen years ago the idea of wireless telegraph for the communication of wireless messages through space was regarded as an impossibility, yet within a year of that date the ‘impossible’ was achieved.”

At Cambridge Consultants we’ve had the privilege, over more than half a century, of working with leading companies in their fields to develop business and technical breakthroughs in a broad range of markets. We’ve invented new products and technologies that provide valuable business advantage in a highly competitive world. Cambridge Consultants develops breakthrough products, creates and licenses intellectual property, and provides business consultancy in technology-critical issues for clients worldwide.

The Perfect Connector ...?

Take the opportunity to decide if Binder's low-cost Snap-in IP67 connectors are the perfect balance of price and performance?

Simple low-cost all plastic modular design

- Cable connectors & moulded cables with up to 12 poles
- Sockets with solder and dip-solder contacts to 7A & 250V

IP67 Snap-in locking mechanism

- Fast, convenient & reliable with over 500 mating cycles
- Internal seals provide water & dust protection

Two compact and lightweight sizes

- Sub-miniature series 620
- Miniature series 720

Versatile Options

- Colour coded versions
- Adaptors for flush mounting

The perfect connector ...?



Unit D, ATA House, Boundary Way,
Hemel Hempstead, Hertfordshire HP2 7SS
Tel: 01442 257339 Fax: 01442 239545
sales@binder-connector.co.uk www.binder-connector.co.uk

... You decide with your
free sample from:

www.binder-connector.co.uk

01442 257339



Telnet

Quality second-user test & measurement equipment

Tel: 02476 650 702 Fax: 02476 650 773

Web: www.telnet.uk.com Email: sales@telnet.uk.com

All equipment is used - with 30 days guarantee and 90 days in some cases. Add carriage and VAT to all goods.
1 Stoney Court, Hotchkiss Way, Binley Industrial Estate Coventry CV3 2RL ENGLAND



Agilent 4192A L/F Impedance Analyser 5Hz-13 MHz	£3000	Agilent E4432B - UN3- (250kHz- 3GHz)Signal Gen.	£2750
Agilent 4195A 10Hz- 500MHz Spectrum An.	£3995	Agilent (HP)4291B 1.8 GHz R/F Impedance Analyser	£8000
Agilent 5350B /51B/ 52B 10Hz-20GHz / 26.5GHz/ 40GHz Freq. Counter	from £1000	Audio Precision System One (SYS-222) Audio /Dist. Analyser	£2200
Agilent 54540C 500 MHz- 4 Ch oscilloscope	£3995	Amplifier Research 150L Power Amplifier 150W (10kHz-200MHz)	£6500
Agilent 54720D with 2x 54721A Plug-ins Oscilloscope 1GHz 4 ch.	£2000	ENI 525LA R/F Power Amplifier 1 - 500MHz, 25 Watts	£2500
Agilent 6574A 60V-35A Power Supply	£1495	Fluke 2635A- 100 Hydra Series Data Logger	£1250
Agilent 81101A 50 MHz Pulse Generator	£3250	Keithley 236 Source Measurement Unit	£1500
Agilent 83630B Synthesised Sig. Gen. 26.5 GHz	£19500	Keithley 237 High Voltage Source Meter	£2750
Agilent 83651B Synthesised Sig. Gen. 50 GHz	£13000	Keithley 486 Picoammeter 5.5 digit	£1100
Agilent 83752A Synth, Sweep Gen. 0.01-20 GHz	£9995	Keithley 617 Programmable Electrometer	£1100
Agilent 85046A 'S' Parameter Test Set 3 GHz	£2000	Lecroy LC334M 500MHz - 4 Ch Oscilloscope	£1950
Agilent 85047A 'S' Parameter Test Set 6 GHz	£3000	Lecroy LC564A 1GHz - 4 Channel dig. Colour Oscilloscope	£2995
Agilent 8508A / 85081B plug-in 1GHz Vector Voltmeter	£2200	Lecroy LC574AM 1 GHz, 4 Channel dig. Colour oscilloscope	£3250
Agilent 8510B and C Network An. 45MHz-26.5 GHz	from £2000	Marconi 2023 Signal Generator 9kHz-1.2GHz	£1500
Agilent 8511A Frequency Converter 45MHz-26.5GHz	£2000	Marconi 2030 10kHz - 1.35 GHz Sig. Gen.	£1995
Agilent 8515A 'S' Parameter Test Set	£2200	Marconi 2031 Signal Generator 10kHz- 2.7GHz	£2250
Agilent 8517B 'S' Parameter Test Set 50 GHz	£5500	Marconi 2051 Signal Generator 10 kHz- 2.7 GHz	£5000
Agilent 8566B 100Hz-22GHz Spectrum Analyser	£2750	Marconi 6203 20GHz Microwave An. Test Set	£6000
Agilent 8592B Spec. An. 9kHz-22GHz	£5000	Marconi 6204B 40 GHz Microwave An. Test Set	£17500
Agilent 8595E Spectrum Analyser with T/Gen. 9kHz- 6.5GHz	£5000	Philips PM3384B 100 MHz - 4 Ch. Oscilloscope	£1750
Agilent 8647A Sig. Gen. 250kHz-1GHz	£950	Rohde & Schwarz FSEB20 -B1,B4,- (9kHz- 7GHz) Spectrum Analyser	£5995
Agilent 8664A (0.1-3GH) Signal Gen.	£2750	Rohde & Schwarz SME03-B%,B8,B11,B12-(5kHz-3GHz) Signal Gen.	£2750
Agilent 8665A 100kHz-4.2GHz High Perf. Signal Generator	£4000	Rohde & Schwarz SMIQ04B 300kHz-4.4GHz Vector Sig. Gen.	£6750
Agilent 8648B / C Sig. Gen. 9kHz-2GHz or 3GHz	from £1800	Solartron 1250 Frequency Response Analyser	£2000
Agilent 8662A High Perf Sig. Gen. 10kHz-1280 MHz	£2000	Solartron 1253 Gain / Phase Analyser	£3000
Agilent 8673B Synth Sig. Gen. 2 - 26.5 GHz	£3750	Tektronix AWG610 Arbitrary Function/ Waveform Generator 260MHz	£6500
Agilent 8673D Synth. Sig. Gen. 0.05-26.5 GHz	£5995	Tektronix 496 Spectrum Analyser 1kHz-1.8GHz	£2200
Agilent 8714B Network Analyser 3 GHz	£5500	Tektronix 2711 Spectrum Analyser 9kHz-1.8GHz	£2000
Agilent 8752A Network Analyser 300kHz-1.3 GHz High Perf.	£3000	Tektronix 2792 Spectrum Analyser 10kHz-21GHz	£4000
Agilent 8753A/B/C Spectrum Analyser 330kHz-3 or 6 GHz	from £2000	Tektronix 784D - 1GHz, 4 channels, 4 Gs/s	£2400
Agilent 8780A 10MHz- 3GHz Vector Signal Generator	£3000	Tektronix TDS754C 500MHz - 4 channel Oscilloscope	£2400
Agilent 8902A Measuring receiver 150kHz-1.3 GHz	£4995	Wayne Kerr AP60150A DC Power supply 3KW, 60V-150A	£1950
Agilent 8970B Noise Figure Meter	£1750	Willtek 4403 (opt GSM, ACPM) Mobile Phone tester	£5750
Agilent E4420B 250kHz- 2GHz Signal Generator	£2000	Yokogawa DL708E and DL716 Dig. Oscilloscope from	£1500
Agilent E4425B 250kHz-3 GHz Signal Generator	£4250		

SMART CITIES OF TOMORROW

WHAT WILL THE SMART CITIES OF TOMORROW LOOK LIKE? **JOSEPH ALDERSON**, TECHNICAL MARKETING ENGINEER AT FARNELL ELEMENT14, OBSERVES THE GROWING FACTORS THAT ACCELERATE THE NEED FOR BETTER INSTRUMENTED, INTERCONNECTED AND INTELLIGENT INFRASTRUCTURE AND DISCUSSES FUTURE TECHNOLOGICAL INNOVATIONS

Global society is changing. In the last 100 years towns and villages have amalgamated into a continuous zone, connected by an ever-expanding road and rail infrastructure. Over the next 10 years as many as 700 million people will join the cities' population and by 2050 it is estimated that more people will inhabit cities than live on the whole of the Earth today.

With such growing urban populations and an increasing demand for services and smarter technology, traditional solutions and rapidly aging infrastructures, such as transport and utilities, will no longer be able to meet the needs they were originally designed for. This huge increase in urban migration will mean that 'smart cities' will no longer be a utopian dream but a reality and indeed an essential requirement.

For this kind of growth to be sustainable, every aspect of our lives – from basic needs to entertainment and leisure – will have to become smart, leading to the cities becoming a lot smarter too.

However, with massive growth comes the potential for massive problems. Many of our cities are patchworks of history: 19th century sewers wind their way through Roman

foundations and fibre optic cables hug the water mains. When we think of smart cities, the temptation is to see glittering spires and a clean modern look, but when the space to develop is not available, we have to work within the confines of the past.

It is small scale, low-power solutions from electronic engineers that are leading the way in making cities smart where the slate can't be wiped clean. Fundamental to the smart city of the future is the notion that technology will make our day-to-day lives simpler and be applied to all aspects of our infrastructure.

Transport

Our crowded, ageing rail networks are increasingly being retrofitted with sensing technology that serves to make them safer, whilst detecting potential problems that could cause delays. Without massive government spending – or starting from scratch – these patchwork modifications to our existing utilities and transport systems will form the core of our future cities. Again, our desire for simplicity spills over into the need for efficiency, and it is here that sensing and automation technology can be effectively used to improve the day-to-day services that we're used to.

A growing number of cities around the world are also returning to more traditional forms of mass transit. Our love affair with the car is on borrowed time, and electrified trolley buses and trams will be a common sight in smart cities of the future as it becomes more and more expensive to run a car. In some European cities trams were never phased out and continue to provide an essential and clean form of transport.

Low cost, low-power systems such as RFID have already been widely adopted for keeping track of products in shops and baggage at airports. As cities become increasingly large and the pressure for efficiency in every service grows, even the rubbish that we generate and would like to forget about requires the re-think of an electronics engineer.

Using low-power systems to keep control of shared residential garbage and recycling facilities would make the process of collecting and disposing of waste much more efficient, and some cities such as Barcelona have already implemented semi-automated block refuse collection.

Water

The water that flows through the pipes of a smart city will more than likely be flowing through much the same distribution network as today. The problems of water scarcity and water loss will become massively important as the world

Figure 1: Smart cities of tomorrow will be even more complex than today



population grows bigger, and measures will need to be taken to limit our consumption. In the US alone 6 billion gallons of water are lost each day, and controlling leakage and limiting water consumption would save \$15bn per year globally, according to the World Bank. Smart solutions from companies such as the Israeli start-up TaKaDu have already been adopted by utility companies seeking to limit water loss.

By combining this kind of software solution with telemetry and smart metering, utility companies have made some inroads into limiting water loss. This example of using innovative electronics solutions to cut down on waste showcases how our cities are becoming smart in our lifetimes. It is by using technology available today that electronics engineers can make even the simplest of utilities smart.

However, questions remain as to what extent it's possible to prop up an ageing infrastructure and if these measures significantly future-proof our utilities.

Communication

It is in communications that it is easiest in some ways to imagine a smart city. 4G networks, HD and superfast Internet are just some of the advances that a few years ago wouldn't have seemed possible.

The fast lane of communication will also need to run in parallel with much lower-power channels. Wireless control of the appliances in our homes is already a reality with some apps allowing us to remotely communicate with a home server to turn on the central heating, or record TV programmes for example. With the move to digital television, significant white space in the RF spectrum has been made available, providing the much needed frequencies that will allow our growing use of telecommunications to expand further.

Despite this, as demand for bandwidth continues to increase, so too will the sophistication of the solutions. The development of Space Division Multiple Access and smart antennae will be critical if our future smart cities are to support the kind of network traffic generated by high-definition audio and video communications.

As we drive around the streets of our smart city, wireless communications between our vehicles will become even more important. Keeping our cars moving through what are now gridlocked streets will reduce emissions, improve trade links and shorten journey times to work.

A combination of dynamic traffic monitoring, GPS and low power vehicle-to-vehicle communications will serve to keep the wheels turning. Aspects of this have already been implemented in many countries, especially "managed" motorways, which are intended to slow traffic down to the speed necessary to avoid jams, though a more cohesive approach will be needed as our cities grow.

Lighting

It will not be the familiar orange glow of the sodium street light that guides us through the cities of tomorrow, but energy-efficient LEDs casting a white light. As the cost of LED illumination decreases, we can expect to see accelerated uptake of LED street lighting throughout our cities. By

replacing existing lighting technology with energy-efficient LEDs we could halve the carbon footprint of street lighting.

Many cities already use LED technology in traffic lights and signals, though uptake of street lighting has been slower with some residents complaining about the perceived brightness of cold colour LEDs. A balance between sleepy residential zones and major routes where a white light will give increased attention-spans will need to be struck in the cities of the future.

Smart Homes And Alternate Energy

It is when we return to our homes at the end of the day where the smart city will have the most impact. Energy recapture, smart metering and personal health monitoring will ensure that our houses are safer, more comfortable and more energy-efficient than ever before. It is in the home that our smart cities will first take root.

With oil and gas prices continuing to climb, alternative energy on a personal scale will become a key feature of housing in the future. Home solar power is already popular, though in the smart city photovoltaic cells will be concentrated on commercial buildings and ground mounts rather than houses.

As cities and the pressure for efficiency in every service grow, even the rubbish we generate and would like to forget about requires the re-think of an electronics engineer

In the smart home, the new, smarter systems will make the most efficient use of electricity and energy harvesting, which will produce the savings required to reduce our overall carbon footprint.

Energy savings will also be made with the centralisation of home computing. What we experience now as the Cloud will become more pervasive, though home servers and centralised computers will be an important step in reducing the number of computers in the home.

With this centralisation will also come the potential to capture waste heat. In larger, commercial buildings, waste heat from the server room could provide an important heat source for the building as a whole.

The Evolution Has Already Begun

Elements of the smart city are already with us today, dispersed throughout the world. The clean tram systems of Strasbourg, the autonomous transportation at Heathrow Airport in London, the solar collectors of Masdar city and the augmented reality many of us use on our smart phones will all one day be key features of our smart cities.

Above all, the technology we need to make our cities smart is here with us today. It is the engineers, the innovators of the world who will be the ones to turn applications once reserved for flashy gadgetry into essential services that keep our utilities, transport and communications running.

(continues on the next page)

INSTRUMENTED, INTERCONNECTED AND INTELLIGENT: SMART CITIES IN THE MAKING

QUAKE AND GAS MONITORING

Today's city councils face many challenges requiring effective monitoring. Atmospheric pollution – in the form of gases such as CO₂ and NO₂ or dust – is a threat to the health of urban dwellers by causing respiratory diseases.

Sensor boards being able to monitor gas, radiation, various particles and vibration could be integrated into wireless networks to build a wide range

of services for quake and gas monitoring, or even more localised applications such as structural health monitoring on buildings. Sensors and networks have so far addressed these within different standards and different vertical applications. A uniform modular approach run on open-source software would allow city councils to enable better infrastructure cost-effectively.

Source: Libelium Ltd.



A SMART CITY OPERATING SYSTEM

Portugal is pioneering a sensory system for a smart city and plans 100 million sensors across an area of just 17km².

The biggest challenge to a smart city becoming reality is the ability to seamlessly analyse and process huge amounts of the data generated in real time,

according to the team of the TU Darmstadt project Cocoon.

The answer to this is channelling

all the data coming from these sensors and services into an over-arching control system via its own operating system.

Urban OS, unveiled in September 2011 by Living Planet IT and its technology partners, is an operating system that could manage communication between sensors and devices such as traffic lights, air conditioning or water pumps that influence the quality of city life. In the event of a fire the Urban OS might manage traffic lights so fire engines can reach the blaze swiftly, or help evacuate people much more quickly and efficiently within nearby or affected buildings.

Source: Living Planet IT, Project Cocoon TU Darmstadt



A SMART ECOSYSTEM IS BEYOND SMART METERS

The introduction of smart meters that will give consumers the option to monitor and control their power consumption online has been much talked-about flagship of smart cities. But this is just the beginning. What if every lightbulb had an IP address?

The possibilities are endless: every lightbulb could be monitored, managed and controlled from any Internet-enabled device – turning lights on and off individually, dimming or creating scenes from smartphones, tablets, PCs or TVs – to save energy as well as electricity.

A "smart lighting" network could have dozens or even hundreds of appliances connected

through a wireless network designed for maximum energy-savings, communicating information about their environment and power consumption levels,

and creating alerts when encountering problems. NXP and its partners revealed in 2011 their Internet-enabled Greenchip Smart Lighting network which starts to shape a whole new dimension in energy-efficient lighting.

Source: NXP



SAVING FUEL AND REDUCING EMISSIONS THROUGH CROWD-SOURCED TRAFFIC DATA

A smart social networking app on dash-mounted smartphones crowd-sources the timing of red traffic lights and shares that information with other drivers to optimise fuel use and reduce emissions.

The SignalGuru app, a project of Massachusetts Institute of Technology (MIT) and Princeton University allows drivers to save an average of 20% fuel use

compared to those that had to stop at traffic light. The app has been worked well in Cambridge, Massachusetts, where traffic lights are on a fixed timing. The system worked less well in Singapore

where traffic light timings vary, but one can envision connected M2M devices being able to track and communicate traffic light timings, as well information from other vehicles, through a real-time database to make roads safer and more efficient.

Source: MIT and Princeton University, USA





UK designed,
UK made,
with pride.

Tel. 01298 70012
www.peakelec.co.uk
sales@peakelec.co.uk

Atlas House, 2 Kiln Lane
Harpur Hill Business Park
Buxton, Derbyshire
SK17 9JL, UK

Follow us on twitter
for tips, tricks and
news.

@peakatlas

For insured UK delivery:
Please add £3.00 inc VAT
to the whole order.
Check online or
give us a call for
overseas pricing.

PEAK[®]
electronic design ltd



“A very capable analyser”

- Detailed review in **RadCom** magazine (March 2013)

As a result of a major product development initiative at Peak Electronic Design Ltd, we are delighted to make this exciting announcement.

£115.95
(£96.62+VAT)

The amazing new **DCA Pro** is now available!

- Just connect your component any way round,
- Graphic display shows detailed component schematics.
- Enhanced component identification, pinout identification and analysis including gain, transconductance, pinch-off, etc.
- USB connectivity for power and communications.
- PC Software included on Peak USB Stick.
- Can be used standalone or with a PC (Win XP or later).
- Curve tracing functions on your PC. (up to: $\pm 12V / \pm 12mA$).
- Supports Transistors, MOSFETs, JFETs, IGBTs, Diodes, Zeners, LEDs, Voltage Regulators and much more!
- Free updates online for PC Software and Firmware.
- Uses a single Alkaline AAA battery (and/or USB power).

We aim to despatch your order as soon as possible. Demand for the DCA Pro is currently very high and that may cause a small delay. We will contact you immediately to confirm expected despatch date and you can cancel at any time of course.



USB cable included



Curve tracing on your PC!



Detailed specs on your PC

It's only possible to show summary specifications here. Please ask if you'd like detailed data. Further information is also available on our website. Product price refunded if you're not happy.

Digital Voice Processor

The CMX7011 is a flexible, half duplex, digital voice scrambler that transmits and receives secure digital encrypted voice via an embedded robust audio-band data modem for analogue radio systems, wireless door access and gate entry systems.

Integrated RALCWI vocoder (royalty free)

Simple integration directly into the radio audio path

Low power operation

Small 48-pin VQFN/LQFP package



TWELP[™]
VOCODER

- Low bit-rate 2400bps
- Integrated audio codec
- Noise reduction system

The CMX7262 is a high-performance low bit-rate TWELP vocoder for professional two-way radio, providing market-leading voice and excellent real-life radio operation.

This is achieved through the use of the latest state-of-the-art voice coding technology called "Tri-Wave Excited Linear Prediction" (TWELP[™]).



RF Building Blocks

The RF Building Block range is designed to provide the flexible, high performance ICs required for HF/VHF/UHF, professional radios, wireless data terminals, wireless microphones, marine and avionics radio systems.

CMX970 - Low Power Quadrature Demodulator

The CMX970 Quadrature Demodulator supports a wide range of modulation types, exhibits high performance over the operating range of 20 to 300 MHz and may be used for conversion to low IF or zero IF (baseband).

CMX971 - Low Power Quadrature Modulator

The CMX971 Quadrature Modulator features excellent modulation accuracy, high performance over the operating range of 20 to 1,000 MHz and provides translation from baseband I/Q signals to a modulated RF signal.

CMX973 - Quadrature Modulator/Demodulator

The CMX973 integrates a quadrature (I/Q) modulator and a low-power quadrature IF/RF demodulator, both featuring a wide operating frequency range and optimised power consumption.

VEHICLES OF THE FUTURE

— SEEING AND THINKING

LARS REGER, VP OF R&D AND STRATEGY AT NXP SEMICONDUCTORS, SAYS THAT SEMICONDUCTORS ARE THE KEY TO SIMPLE, SECURE, SAFE AND CONVENIENT MOBILITY IN THE WORLD'S MEGACITIES

In the world's megacities, traffic infrastructure often looks like it is collapsing under the weight of exploding population growth. Congested roads, traffic noise, the risk of accidents and general stress are all part of daily urban lives. Intelligent traffic management will be required to ensure the future of mobility in such crowded urban areas.

Despite double-tier multi-lane freeways in Shanghai or Beijing, multi-hour traffic jams are an everyday scene in these cities of millions. And every week some 10,000 vehicles are newly registered to join the queues. Meanwhile, urban dwellers are on the brink of suffocating from their own air pollution.

Ironically, the more mobile the population becomes, the more slowly people can expect to get where they want to go when they take to the road. Consequently, metropolitan areas worldwide are searching for sustainable infrastructures and mobility concepts.

Authorities in many cities in Asia have realized that, in the long-term, simply building more roads, tunnels or overpasses cannot relieve major traffic junctions of their daily load. Increasingly, governments are beginning to take a regulatory role. Toll systems to control traffic flow, high registration fees or limiting accessibility to city centres depending on a number plate are all measures that have been introduced with varying degrees of success in an attempt to provide some relief from growing congestion. Municipalities have also started cooperating with industry to create systems for efficient traffic management of both private and public transportation.

Vehicles That Can See And Think

Intelligent automobiles can master today's traffic problems; cars that "think" can take a load off the driver by

figuratively "taking the wheel", such as when it comes to choosing the right route or driving in an energy-efficient manner. In the future, such cars will be capable to literally take the wheel. This intelligence is facilitated by networking systems in the car and by extending this network wirelessly to the infrastructure.

Networking solutions of this kind can enable traffic lights and vehicles to "talk" to one another and regulate the flow of traffic. Traffic lights would tell drivers the right speed to drive through the city in order to minimize the number of red lights they come across. Obstacles such as construction sites, traffic backups or danger spots would be reported to drivers so they can adapt their routes. Public buses would receive priority through a traffic management system with telematics and car-to-car communication, enabling them to maintain better schedule reliability. Such improved traffic flow not only gets you to your destination faster, it also shows up positively in a city's carbon footprint.

Asian megacities, given the positive experience with telematics systems, are now assessing concepts for enhancing road tolling system. With satellite support, tolls can be levied by route, volume of traffic or time of the day – and no longer as a function of the driver's destination, allowing drivers to plan their routes more efficiently and rewarding them with lower charges.

E-Ticketing Simplifies Local Transport

Public local transport agencies in China's megacities like Beijing, Shanghai and Hong Kong are also looking to modern chip systems as an answer to the daily onrush of commuters, with payment of fares based on RFID or Near-Field Communication (NFC).



Car-to-car and car-to-environment communication will be commonplace in the future

The future car will use many different types of technologies to run efficiently and offer comfort and safety for its passengers and the environment

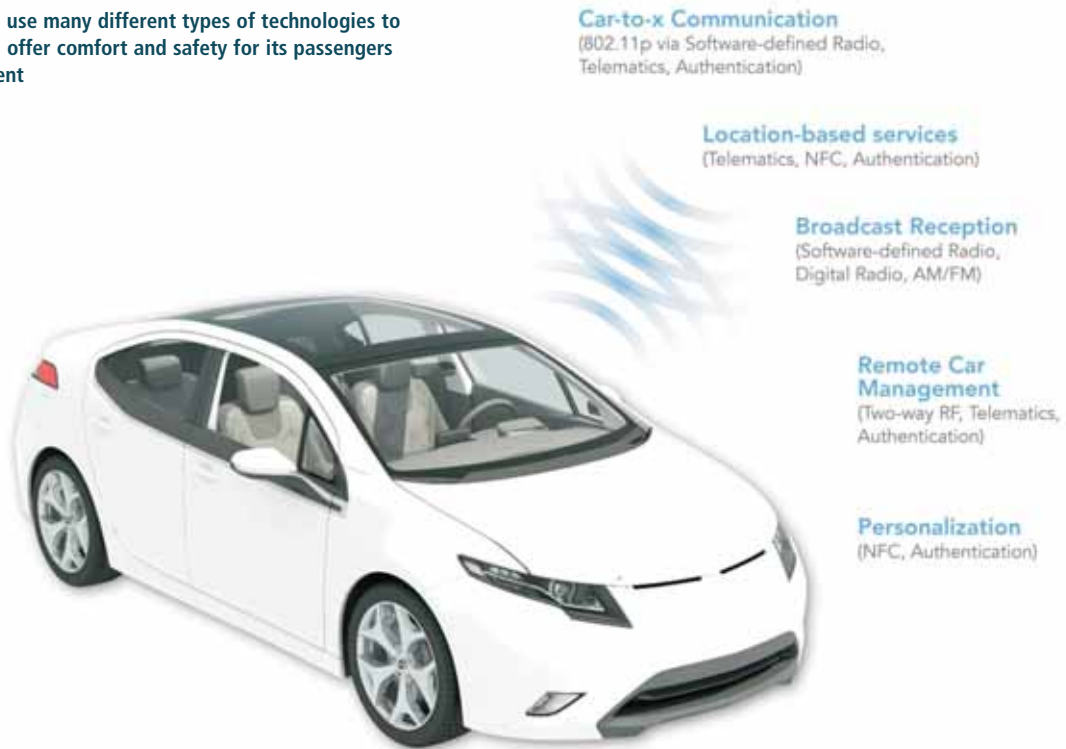

In e-ticketing, passengers buy virtual tickets without a long queue by using a transport card or cell phone – NFC chips are integrated into the cell phone for this purpose. These electronic chips are able to securely transmit data to a reader over short distances of a few centimeters. At the start and end of the journey, the person passes their cell phone over the reader terminal to automatically complete payment for the distance travelled. Given the pervasiveness of cell phones, this simple and cashless method of payment is now also being used for parking tickets or entrance tickets to a variety of events.

Authorities in many cities have realized that simply building more roads, tunnels or overpasses cannot relieve major traffic junctions of their daily load

China is assuming a leading role in contactless payment by cell phone, as shown by e-ticketing systems in 130 of its major cities. An increasing number of German transport authorities are taking up the example and testing NFC technology in pilot projects, such as in the public transport networks of the Rhine-Main and Rhine-Ruhr conurbations.

Mobile Vision For The Future

E-ticketing by cell phone is just a first step towards implementing a new vision of traffic and transportation. From a technical point of view, it is already possible for a cell phone to combine in one electronic device the functions of an identity card, driver's license, credit card and various keys, including home, car or hotel keys. This makes urban mobility concepts imaginable in which the cell phone, as a densely integrated communication platform, selects the optimum type of transport.

A destination chosen by cell phone navigation can be approached, depending on the traffic situation, by public transport, taxi or car-sharing rental. The cell phone acts as the means of payment for a bus ticket and taxi charge or even opens the door of a shared rental car parked nearby. The cell phone makes authentication of the driver and billing by distance traveled quite convenient.

Equally, a two-way communication in the latest generation of smart car keys can get information on the car's status like fuel levels, state-of-charge for e-Vehicles, alarm activation, or GPS coordinates. Drivers can remotely turn on the air-conditioning over distances of hundreds of yards. Using intelligent car keys in combination with a navigation-enabled smart phone, car owners can determine the car's location and easily find their parked car.

Smart car keys, NFC, NXP's Automotive Telematics Onboard-unit Platform (ATOP) and the CarITS Platform make it possible

The future vehicle will rely on all types of communications systems for efficiency, safety and comfort



to implement a variety of applications that simplify and improve urban mobility. Asian megacities have a pioneering role to play here. In this connected mobility vision, the car is no longer the classic status symbol of the past, representing an isolated means

of personal transportation, but becomes a central part of the Internet of Things. Connected mobility is the key enabler to make transportation more efficient, convenient and safe and guides the way toward modern urban-transportation. ●

ENABLING CARS AND DRIVERS

Semiconductor maker NXP is the leader in interfacing electronics within the car, developing technology for telematics and Intelligent Transportation Systems (ITS). NXP's Automotive Telematics Onboard-unit Platform (ATOP) and IEEE802.11p CarITS platform give vehicles the capability to interact and exchange information with their environment, including car-to-car and car-to-infrastructure communication.

Field trials are already in progress worldwide. Asian megacities have been testing the ATOP solution since 2010. The aim is to navigate vehicles through the city faster and in a way that's better for the environment by employing such a telematics system. Road or traffic conditions can be analyzed by vehicles in real time and used to choose the fastest route, saving fuel and reducing emissions.

In Europe there are already field trials under way on a telematics-based road toll that uses the NXP ATOP solution. A GPS receiver determines the location of a vehicle while a mobile GPRS network continuously sends the miles driven over ATOP to computerized back-office infrastructure. In this way the toll is calculated for the exact distance driven. This pay-as-you-drive approach replaces conventional means of payment per vehicle and thus is more fair for the individual consumer. Furthermore, different charges can be applied during rush hours and in heavily congested regions. During field trials in the Netherlands, it has been shown that drivers optimize their route to avoid these peak times and routes and choose less expensive alternative roads. It has been calculated that with this approach traffic jams can be reduced by more than 50%.



HP8560E SPECTRUM ANALYSER
30HZ-2.9GHZ with Tracking Generator
£3,500

HP8560 SERIES SPECTRUM ANALYSER Frequency up to 26GHZ
Various Models from £2,500-£7,000



HP83731A/B SYNTHESISED SIGNAL GENERATOR
1-20GHZ Various Options
£4,000-5,000



TEKTRONIX TDS784D 4 Channel 1GHZ 4GS/S
breakdown tester
Opts 05/11M/2M/3C/4C no Probes
£2,750

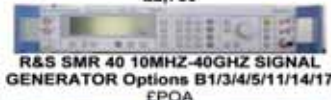

R&S SMR 40 10MHZ-40GHZ SIGNAL GENERATOR Options B1/3/4/5/11/14/17
EPOA



RACAL 1792 RECEIVER
£300

AGILENT E4402B Spectrum Analyser
100HZ - 3GHZ with Option 1DN Tracking
Gen; 1 DR Narrow Res; A4H GPIB,
UKB.....£5800
HP 35670A FFT Dynamic Signal Analyser
2 Channel. Unused in original box...£4000
AGILENT 83752B Synthesised Sweeper
0.01-20GHZ.....£6000
HP83711B Synthesised 1-20GHZ with
Opt IEI Attenuator.....£5000
AGILENT/HP E4431B Signal Generator
250KHZ-2GHZ Digital Modulation...£2750
MARCONI 2024 Signal Generator 9KHZ-
2.4GHZ Opt 04.....£1250
MARCONI/IFR 2030 Signal Generator
10KHZ-1.35 GHZ.....£995
MARCONI 2022E Synthesised AM/FM
Signal Generator 10KHZ-1.01GHZ...£500
HP8566A Spectrum Analyser 100HZ-
22GHZ.....£1950
HP8568A Spectrum Analyser 100HZ-
1500MHZ.....£1250
AVCOM PSA-37D Spectrum Analyser
1MHZ-4.2GHZ.....£-
IFR 1200S Service Communication
Monitor.....£1500
HP6624A Power Supply 0-20V 0-2A
Twice, 0-7V 0-5A; 0-50V 0.8A
Special price.....£350
AVO/MEGGAR FT6/12 AC/DC
breakdown tester.....£400-£600
MARCONI/IFR/AEROFLEX 2025 Signal
Gen 9KHZ-2.51GHZ Opt 04 High Stab
Opt 11 High Power etc As New.....£2500
SOLARTRON 1250 Frequency Response
Analyser 10uHZ-65KHZ.....£995
HP3324A Synthesised Function
Generator 21MHZ.....£500
HP41800A Active Probe 5HZ-500MHZ
.....£750
ANRITSU MS2601A Spectrum Analyser
10KHZ-2.2GHZ 50ohm.....£750
AGILENT E4421B 250KHZ-3GHZ
Signal Generator.....£2500

HP53131A Universal Counter Opt 001
Unused Boxed 3GHZ.....£850
Unused Boxed 225MHZ.....£595
Used 225MHZ.....£495
HP8569B Spectrum Analyser 0.01-
22GHZ.....£995
HP54616C Oscilloscope Dual Trace
500MHZ 2GS/S Colour.....£1250
QUART LOCK 10A-R Rubidium
Frequency Standard.....£1000
PENDULUM CNT90 Timer/Counter
/Analyser 20GHZ.....£1950
ADVANTEST R3465 Spectrum
Analyser 9KHZ-8GHZ.....£-
HP Programmable Attenuators £300
each
33320H DC-18GHZ 11db
33321G DC-18GHZ 70db
Many others available
AGILENT E3610A Power Supply 0-8v
0-3A/0-15v 0-2A Unused
AGILENT E3611A Power Supply 0-20V
0-1.5A/0-35V 0-0.85V Unused
HP6269B Power Supply 0-40V 0-50A
.....£400
AMPLIFIER RESEARCH Power
Amplifier 100DLAM8.....EPOA
MARCONI/IFR 2945/A Radio
Communication Test Sets with options
.....from £3,000
MARCONI 2955/A/B Radio
Communication Test Sets..... from £625
MARCONI/IFR 6200/6200B Microwave
Test Set.....£-
HP33120A Function Generator
100 MicroHZ - 15MHZ Unused Boxed
.....£595
Used, No Moulding, No Handle.....£395
ENI 3200L RF Power Amplifier
250KHZ-150MHZ 200W 55Db...EPOA
CIRRUS CRL254 Sound Level Meter
with Calibrator.....£95
CEL328 Digital Sound Level Meter with
CEL284/2 Acoustical Calibrator.....

SPECIAL OFFERS

MARCONI 2305 Modulation Meter.£295
MARCONI 6960B Power Meter with
6910 Sensor 10MHZ-20GHZ.....£295
HAMEG 605 Oscilloscope Dual Trace
60MHZ.....£125
BLACK STAR 1325 Counter Timer
1.3GHZ.....£95
HP8484A Power Sensor 0.01-18GHZ
0.3nW-10uW.....£125



ANRITSU 54169A
Scaler Network
Analyser 0.01-
40GHZ EPOA

ANRITSU 37247C
Vector Network
Analyser 0.04-
20GHZ EPOA

Many Accessories
with each unit

FLUKE SCOPEMETERS 99B Series II
2Ch 100MHZ 5GS/G
..... from £325
97 2Ch 50MHZ 25MS/S..... from £225

STEWART of READING

17A King Street, Mortimer,
Near Reading RG7 3RS
Telephone: 0118 933 1111
Fax: 0118 933 2375
9am - 5pm Monday - Friday

Used Equipment - **GUARANTEED**
Prices plus Carriage and VAT

Please check availability before
ordering or CALLING IN

PCB-POOL
THE ORIGINAL SINCE 1988
SATA LAYOUT

FREE Stencil
with every prototype order

Embedded RFID
authenticate, track & protect
your product

www.magic-pcb.com

Free Phone UK: 0800 389 8560
sales@pcb-pool.com

PCB-POOL® is a registered trademark of
Beta
LAYOUT
create electronics

**Interchangeable (RT Curve Matched)
NTC Thermistors**

ATC Semitec now stock a full range of SP series interchangeable NTC thermistors that offers very high precision ($\pm 0.2^\circ\text{C}$ 0-70C or better) at significantly lower pricing to that of existing interchangeable NTCs.

This allows a wider range of users to achieve more accurate temperature control and thus more energy-efficient and comfortable working environments.

The chief features of the SP range are as follows:

R25 Values	: From 1k Ω to 100k Ω
Accuracy	: $\pm 0.2\text{K}$ from 0°C - 70°C
Temperature Range	: -40°C / +150°C
Fast Response	: 2.6mm Bead Size

Call us today for evaluation samples and ex-stock pricing.
ATC Semitec Ltd
Tel: 01606 871680
Fax: 01606 872938
E-mail: sales@atcsemitec.co.uk

www.atcsemitec.co.uk

FMCONNECT – PLEASE CONNECT ...

Modern interfaces from the PC world – such as USB and Ethernet – are making huge inroads into industrial applications. The FMconnect ECO System supports engineers throughout the process of integrating these communications standards into their own applications.

Dirk Fischer, Senior Product Marketing Engineer at Fujitsu Semiconductor Europe

Following the pervasive migration from PC to the consumer market by the Universal Serial Bus (USB) and Ethernet, these interfaces are now also making headway in embedded systems and industrial applications. Compared to UART, USB and Ethernet offer more advanced features. With USB, for example, a physical interface with only four wires can be used to provide both the device's supply voltage as well as multiple logical communication channels. A microcontroller can function as the USB host – the bus master – and serve a wide variety of device classes, such as flash drives, mice and keyboards. Alternatively, the controller can itself be connected to a bus master as a 'USB device'. Significantly higher transfer rates are also achievable. As an illustration a 100 Mbps Ethernet MAC, implemented on standard microcontrollers, is a thousand times faster than a PC-UART, while a full-speed USB interface, running at 12 Mbps and thus USB 2.0-compatible, is faster by a factor of 120.

The potential disadvantages are that the enhanced function set increases complexity and programming effort – both of which rise significantly.

THE CHALLENGE

Developers are under pressure to accelerate completion of device and solution designs. There is continuous demand for ever more rapid product time-to-market to give the company an edge in its industry and ensure it can stay competitive. These demands have to be met while facing rising complexity and increased development effort.

With FMconnect, Fujitsu provides hardware and software developers with a practical toolset minimising development time. The package covers all aspects of developing embedded systems where advanced communication features are required, from the microcontroller portfolio and development environment – including software utilities and evaluation boards – to libraries and sample applications.

The various FMconnect components are introduced below, using a typical project as an example. In the chosen scenario, the primary goal is for an existing configurable electronic controller for brushless DC motors needs to have its interface for parameterisation and diagnosis

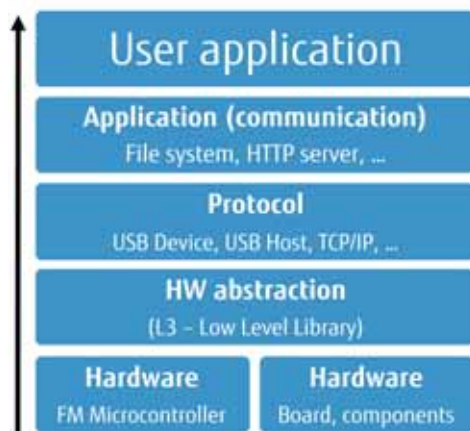

Figure 1: Application implementation levels



converted from RS232 to USB. A secondary objective is to have a scalable migration path to offer a higher-spec model that uses Ethernet for its service interface.

USING THE RIGHT BASE MCU

The application will need an MCU with superior processing power, plus specialised motor control timers for PWM generation and a USB and/or Ethernet interface. The FM MCU family offers suitable microcontrollers. The family in question is a scalable platform of ARM Cortex-based microcontrollers from Fujitsu. The portfolio includes over 460 separate Cortex M3 derivatives, including 150 types with USB, 100 with CAN and 25 with Ethernet MAC. Other types – also featuring Cortex M0+ and Cortex M4 CPUs – will follow this year. Housings offered range from small (32-pin) to large (176-pin) models while on-board flash RAM varies from 64 KB to 1 MB.

In terms of balancing cost against performance, a fully integrated solution is usually the best choice. For the application scenario described above, this would mean selecting the MB9B310S series. With a 144 MHz CPU clock, 3 motor timers – each featuring 6 PWM signals – a USB interface and up to 1MB Flash, the MCU easily handles demanding control tasks. For the high-end device with Ethernet interface also mentioned, the compatible MB9B210S series is used instead, which also offers 10/100 Mbps and an IEEE802.3-compatible MAC.

MATCHING EVALUATION BOARDS ACCELERATE THE DEVELOPMENT PROCESS

System development cycles can be shortened considerably by using appropriate starter-kits for hardware reference. Application software can also proceed independently based on these starterkits, too. They permit software development to take place in parallel, thus saving valuable time. Here, the developer can choose from a range of boards offering different system set-ups.

SOFTWARE REQUIREMENTS

The most time-consuming part of converting the application to USB or Ethernet is likely to be found in software development. In the given scenario, the developer needs to consider both the embedded system and the host PC. Two solution strategies are possible here: strategy one

```
typedef struct stc_mfs_config
{
    en_mfs_mode_t          enMode;
    en_mfs_clk_src_t       enClockSource;
    uint32_t               u32DataRate;
    en_mfs_parity_t        enParity;
    en_mfs_start_stopbit_t enStartStopBit;
    en_mfs_characterlength_t u8CharLength;
    boolean_t              bBitDirection;
    boolean_t              bSyncClockInversion;
    mfs_tx_cb_func_ptr_t   pfnTxCallback;
    mfs_rx_cb_func_ptr_t   pfnRxCallback;
}

```

Figure 2: Excerpt of an L3 (low-level library) configuration structure for the MFS communications module

maintain legacy RS232 interface; strategy two to adopt USB or Ethernet to supersede the RS232 interface. With strategy one, the existing PC-based parameterisation software – designed to communicate via the RS232 standard – is going to be retained, then a virtual COM port driver can be implemented in the embedded system. In this case, the hardware is connected to the host PC via USB but otherwise behaves as an RS232 interface. Similarly, strategy two with Ethernet and an embedded web server normally requires no further consideration to be given to the PC end, since common standards such as HTTP, SMTP or FTP can be deployed, enabling the use of off-the-shelf applications such as web browsers. PC software development work needs to be planned only if specific USB features need to be used – such as one of the four dedicated USB transfer types, for example.

BOTTOM-UP: HARDWARE ABSTRACTION

At least that’s the theory. Yet how can developers implement these solutions – and without wasting time? Depending on the degree of interface control and know-how that is desired or required, the developer can deploy low-level drivers, protocol stacks and complete application implementations (Figure 1).

At the hardware abstraction level, Fujitsu offers CMSIS header files and the “L3” (i.e. Low-Level Library). Available in source code form, this library is not limited to the communication interfaces but encompasses all of the peripheral blocks. The user also enjoys the benefits of a uniform programming interface (API). The h/w blocks are configured via in-memory structures (Figure 2) that are passed to the L3, which then evaluates these in order to programme the h/w register.

USB Device
Low Level Library
HID (Human Interface Device) mouse
HID (Human Interface Device) keyboard
Virtual COM port
LibUSB driver on PC
USB Host
Low Level Library
HID (Human Interface Device) mouse
HID (Human Interface Device) keyboard
Mass storage class
Ethernet
Low Level Library
uIP sample implementation
lwIP sample implementation

Table 1: Supported USB interface use cases



Figure 3: Fujitsu's FMconnect ECO system offers a set of hardware components, software components, tools and documentation

PROTOCOL/APPLICATION LAYER

If we now look at the overall project, it is clear that completing the hardware abstraction layer gets us nowhere near a full USB or Ethernet solution, since we are still missing the protocol layers.

These are also available to developers in source code form. If the L3 is used, deploying the FMconnect package implements USB Device and USB Host while also porting two separate open source TCP/IP stacks. From the protocol layer up, commercial products from third-party suppliers can also be considered.

The proverbial “icing on the cake” is provided by the application layer. Support is available for almost any USB interface use case (Table 1). For Ethernet, the web server – part of the lwIP (lightweight TCP/IP) project – is a prominent feature.

The easiest approach is to use the Template Generator USB Wizard to set up an empty project as the starting-point for your development work. Selection of the required software components and target hardware is GUI-driven, and the corresponding project is generated automatically in a matter of minutes.

Workshops are the final component in the FMconnect package and they also deserve a mention here. We help developers get up to speed on USB Device, USB Host and Ethernet topics by offering themed workshops focusing on practical issues at regular intervals.

CONCLUSIONS

Even without prior knowledge, developers can use FMconnect for the rapid implementation of USB or Ethernet functionality. Proven libraries are available that allow adopters to have confidence in robust and reliable implementations. Nor do developers need to bother with the ‘guts’ of the protocols: instead, they can concentrate on their key project requirements – such as motor drive systems in the above example. Similar solutions for capacitive sensor and motor control systems are also offered by FMtouch and FMInverter.

CAN IN AUTOMOTIVE APPLICATIONS: A LOOK FORWARD

NICOLAS NAVET (INRIA/REALTIME-AT-WORK) AND HERVÉ PERRAULT (PSA PEUGEOT-CITROËN) LOOK AT THE PAST AND FUTURE OF THE CAN BUS IN AUTOMOTIVE APPLICATIONS

To date, there are more than 20 years of experience in automotive Controller Area Network (CAN) applications, and CAN has certainly proven very successful as a robust, cost-effective and all-around network technology. Specifically in automotive applications the use of CAN continues to evolve, influenced by complex and heterogeneous architectures involving FlexRay or Ethernet, and the new needs of hybrid and electric propulsion cars.

The Advent of CAN

In the mid 80s, car makers were facing the problem of increasing wiring and connectors inside the car. This was due to data being exchanged through point-to-point links between the ECUs (electronic control units), along with the quickly increasing need for information exchanges among electronic systems that were gradually replacing the purely mechanical or hydraulic in-car systems. Issues such as these motivated the use of multiplexed communication networks, such as a VAN or CAN, for interconnecting engine control, automatic gear box, junction box, body control and other ECUs.

CAN's robustness and performance, as well as the new possibilities brought on by distributed software functions, motivated

engineers to use more and more bandwidth, a trend that has never decreased since. CAN bus data rates have doubled (e.g. 250kbit/s for a body network when it used to be 125kbits) and load levels have increased too (to greater than 50%, see [4]).

At the beginning just few ECUs were connected, but today there are thousands of signals exchanged by several tens of ECUs, with some signals having timing constraints of less than 5ms. The use of several CAN clusters also raises technical issues relating to fault-handling, diagnosis timing response, wake-up and sleep synchronization among others.

Facing the electrical and electronic architecture's complexity, car makers have developed their own toolsets and established rigorous development processes.

Optimizing CAN Networks

When CAN was introduced, the bus loads were limited (see [15] for a typical set of messages in applications from 1995 to 2000) and the specifications of the communication stack features, priorities and periods etc, were defined more to handle scalability and overcome microcontroller limitations than for bandwidth optimization.

Optimizing CAN networks, which includes reaching higher load levels, has now become an industrial requirement for several reasons:

1. It helps to master the complexity of the architectures.
2. It reduces hardware costs, weight, space, power consumption, etc.
3. It facilitates an incremental design process.
4. It may avoid the industrial risk and the time to master new technologies.
5. It leads to better communication performance and helps to match the bandwidth needs. Sometimes a 60%-loaded CAN network can be more efficient than two 40% CAN networks interconnected by a gateway, causing delays and high jitter rates.

The first obvious way to optimize a CAN is to keep the amount of data transmitted to a minimum, specifically limiting the transmission frequency of the frames. This requires a rigorous identification and traceability of the temporal constraints. Given a set of signals or frames and their associated temporal constraints (freshness, jitter, etc), there are a few additional configuration levers that can be pulled:

1. Desynchronize the stream of frames by using offsets (see Figure 1). Refer to [14] for comprehensive experiments on the large gains achieved using offsets.
2. Reassign the priorities of frames, so the priority order better reflects the timing constraints.
3. Re-consider the frame-packing [17] (i.e. allocation of the signals to the frames and choice of the frame periods), to minimize the

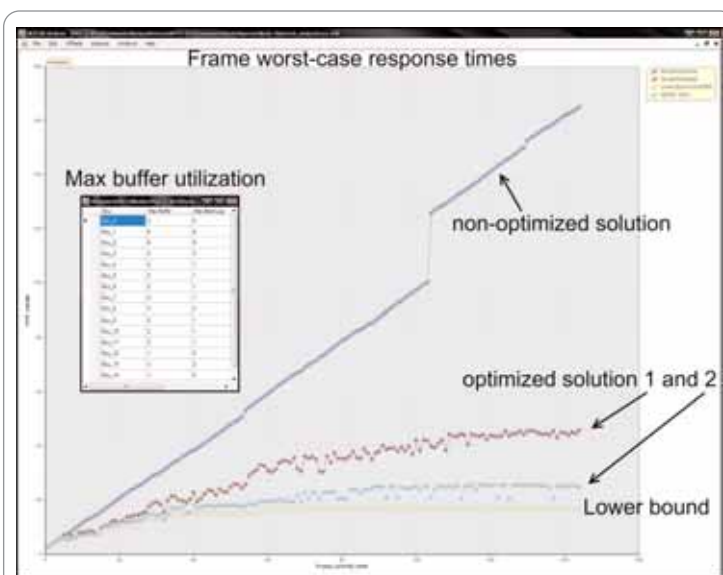

Figure 1: Screenshot of NETCAR-Analyzer, showing maximum buffer utilization and CAN frame worst-case response times (by decreasing priority) for different offset configurations. This graph shows the typical gain one can expect with offsets

bandwidth usage while meeting timing constraints.

- Optimize the ECU communication stacks to remove all implementation choices that cause a departure from the ideal CAN behaviour (see below).

Configuration and verification algorithms used for 1, 2 and 3 have to guarantee the temporal behaviour of the communication system and, ideally, be optimal or provide lower bounds on their efficiency.

In our view, a bus load threshold for an “easy” CAN cluster integration is around 35-40%, and below this limit the latencies and freshness constraints are rather easily “managed”. Overcoming this limit implies more detailed supplier specifications on the one hand and, on the other, to spend more time and effort in the integration/validation phase.

Bridging The Gap Between Models And Implementations

Early in the development cycle, when ECUs are not available, simulation models and analytical models are the two possible verification techniques. As explained in [11], both provide complementary results and, most often, none alone is sufficient.

On the one hand, numerous experiments (as discussed in [11, 13]) suggest that simulation alone is not appropriate to find the worst-case scenarios because they are too rare (see Figure 2). On the other hand, worst-case analysis cannot help to quantify how rare these events are or how long they last, or the average (or any other relevant statistics) response times.

However, it is possible to derive by analysis the phasing conditions between ECUs, specific to each frame, that cause its worst case response time. Then, using a simulation tool it becomes possible to observe how long this situation lasts and where the ECU clock drifts lead from there. Such simulations also contribute to validating the results obtained from the analysis tool (see Figure 3), which is needed because these tools are usually commercial ‘black boxes’ and, although progress is steadily being made [3, 4, 9], they have to make simplifications about the hardware and the communication stack [13]. Besides, because of the complexity of the schedulability analyses, there is always the risk that the tool implementation – or even the analysis itself – is flawed, as it turned out to be the case with the basic CAN schedulability analysis (see [3]).

There are now commercial off-the-shelf (COTS) tools to support verification, even freely available tools such as RTaW-Sim [2] for simulation and NETCAR-Analyzer [1] for schedulability analysis. For CAN, analysis consists mainly of schedulability analyses,

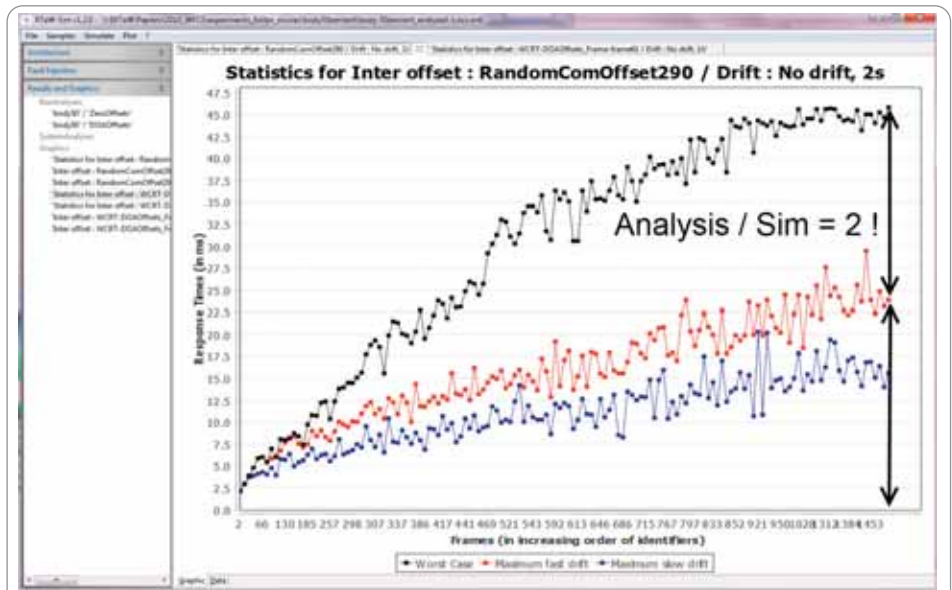

Figure 2: Worst-case response times (by decreasing priority of the frames) obtained by analysis (black curve) versus maximum values collected during long simulation runs for two ECU clock drift values (screenshot of RTaW-Sim [2])

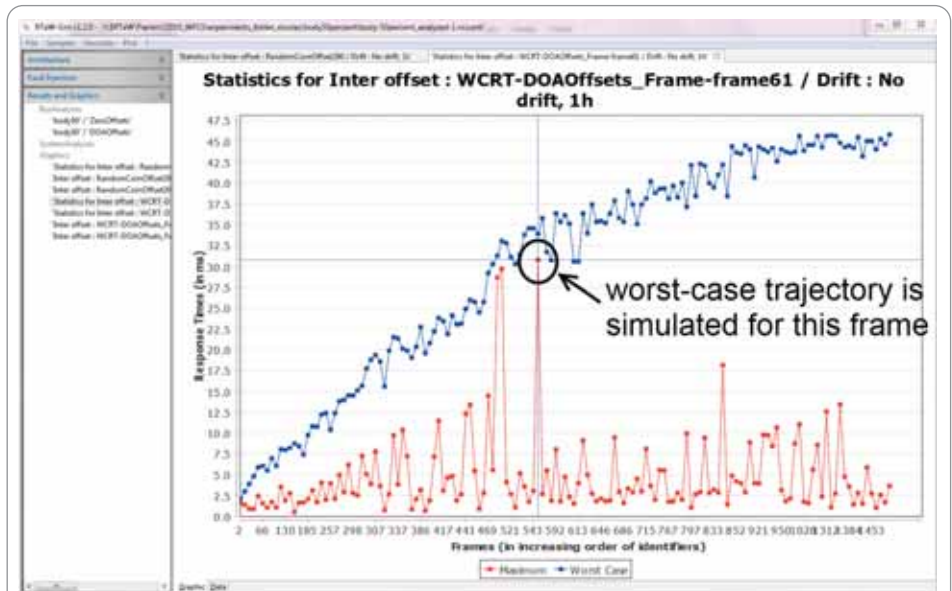

Figure 3: Worst-case response times (by decreasing priority of the frames) obtained by analysis (blue curve) versus maximum values collected by simulation. The trajectory that was simulated here is the one leading to the worst-case response time for a specific frame. As the black circle shows, the worst-case response time for that frame is close to what can be obtained by simulation

providing upper bounds on the considered performance metrics: latencies, transmission jitter, size of the waiting queues at the ECUs and gateway levels, and so on.

Higher Bus Loads Require Fine-Grained Models

Optimized CAN networks means higher network loads and, indeed, they may now easily exceed 50%. But because there is less slack, there is a need for models that are more fine-grained than they were in the past. In particular, models should now account for:

- Transmission errors [15] and, possibly, ECU reboots.
- The use of a periodic communication task responsible for building the frame and issuing the transmission requests. In some cases,

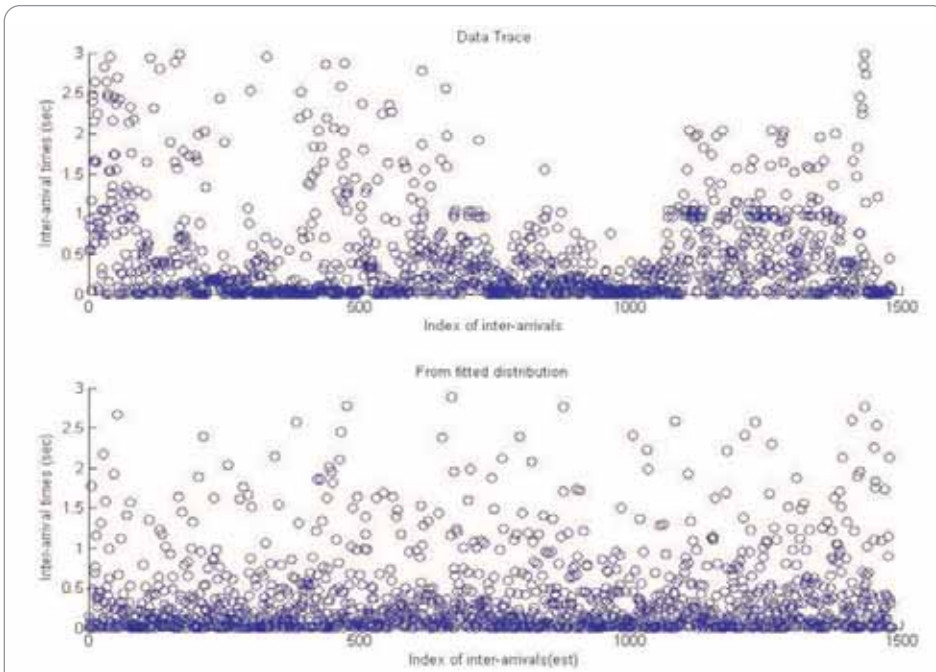

Figure 4: On the two graphs, the X-axis shows the index of the aperiodic frames while the Y-axis is the time between two successive aperiodic transmissions. The upper graph is a real data trace collected while driving (only the aperiodic frames). The lower graph is an artificial data trace generated with a probabilistic model of the aperiodic frames (here Weibull interarrivals with parameters fitted with maximum-likelihood estimation using the real data trace). The probabilistic model can be used both for simulation and worst-case analysis, as done in [14]

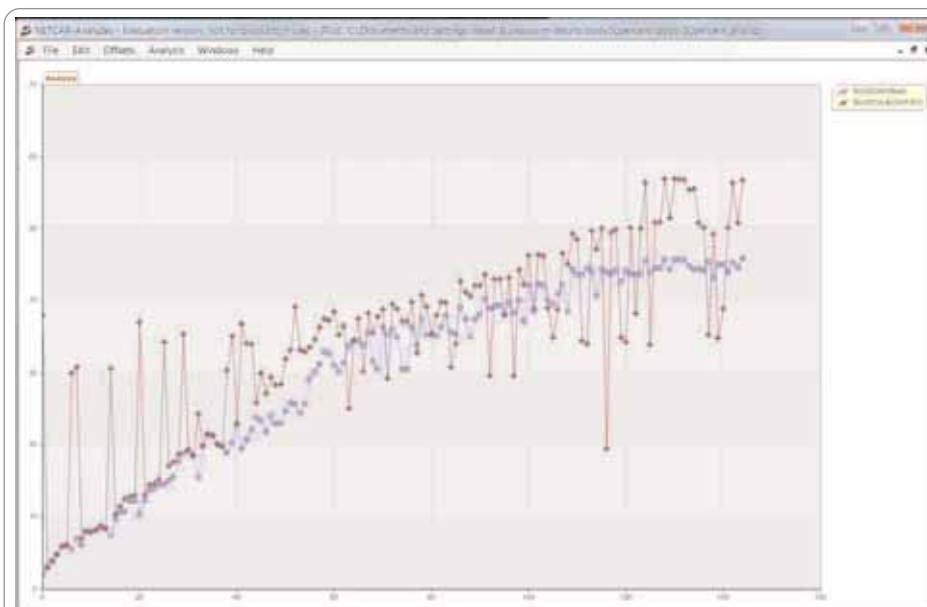

Figure 5: Frame worst-case response times by decreasing priority on a typical body network. The blue curve shows the results when all nodes have prioritized waiting queues for the frames. The red curve shows the actual worst-case response times when there is one station (out of 15) that possesses a FIFO waiting queue. As one can observe, in the latter case many high priority frames will suffer more delays, and potentially they may not respect their timing constraints (e.g. deadline, jitter in reception)

this frame may suffer delays caused by higher priority activities.

- Possible asynchronisms between the applicative level tasks that produce the signals and the communication task. Sometimes such delays can be longer than the latencies on the CAN bus.
- More fine-grained models of the hardware and communication stack (see below). For instance, taking into account the ECU clock drifts may change drastically the conclusions that can be drawn from a simulation [11]. The same holds for a worst-case schedulability analysis [4, 9] when explicitly modeling a FIFO waiting queue.
- Better characterization of the traffic, in particular the non-periodic part [14] and the transmission jitter (especially for frames that are forwarded from one network to another). The non-periodic traffic is generally difficult to characterize, but if overlooked, one tends to underestimate the frame latencies as shown in [14] which, in the worst-case, may have an impact on the safety.

Departure From The Ideal CAN Behaviour

Until recently analytical models were often much simplified abstractions of reality: usually overly pessimistic (e.g. regarding the non-periodic traffic) and sometimes even optimistic, which means unsafe in our context. Indeed not all the classical assumptions made on the ideal CAN scheduling model are met by the implementations. Examples include:

- Non-abortable transmit request [7] (some communication stacks/controllers may not offer the possibility to cancel lower-priority transmission requests when a higher priority frame is released).
- Limited number of transmit buffers [5, 6].
- Delays in refilling the transmit buffers [6].
- The use of a FIFO waiting queue for frames, or any other policy than the Highest Priority First (see Figure 5). The reader may refer to [4, 9] for an in-depth treatment of this topic.
- Internal CAN controller message arbitration based on transmit buffer number rather than frame ID.
- Frame queuing not done in priority order (but for example by PDU index in Autosar) because of the communication stack.

Whether or not the CAN communication stacks will depart from the ideal CAN behaviour may in practice make a large

difference in terms of performance and predictability. For instance, a single station with a FIFO queue can create bursts of high priority frames that will impact the latencies of the frames sent by all the other stations (see Figure 5 and experiments in [9]), possibly it may even propagate to other networks through the increased jitters of the frames that are forwarded through the gateways.

Generally, if the integrator does not have control over the communication stacks of all the ECUs that make up a system, conservative assumptions for the validation should be used. Fortunately, since the identification of a flaw in the original CAN schedulability analysis [8], in our view significant progress has been made and the main issues have been identified and accounted for in the schedulability analysis (see references [3-9]).

Better adherence to CAN priority behaviour can be enforced by more detailed and more constraining specifications for suppliers. Also, to some extent the verification can be performed by tools that analyze transmission traces such as RTaW-TraceInspector.

New Technologies

When an EE architecture requires more than three or four CAN clusters, it could be a better choice to introduce a new networking technology. As the most important needs for CAN bandwidth come from the powertrain and chassis domains, a “natural” technology is FlexRay, which provides 10Mbit/s and time-triggered features. Another technology which should be considered in the future to increase bandwidth is the upcoming CAN FD from Bosch, which may provide a good trade-off between the difficulty of the migration path and additional bandwidth availability.

Nevertheless, in many cases, optimizing the standard CAN networks will help defer the introduction of new technologies, at least for a subset of car domains. However, using CAN at higher load levels requires additional time and effort, whether for supplier specifications or verification. But in our view the current state of the technical literature on CAN and the COTS software tools are now mature enough to alleviate this additional work and lead to success building truly safe and optimized CAN-based communication systems. ●

REFERENCES

- [1] RealTime-at-Work, “NETCAR-Analyzer: Timing analysis and resource usage optimization for Controller Area Network,” downloadable at <http://www.realtimeatwork.com/software/netcar-analyzer/>, 2009.
- [2] RealTime-at-Work, “RTAW-Sim: Fine-grained simulation of Controller Area Network with fault injection capabilities”, downloadable at <http://www.realtimeatwork.com/software/rtaw-sim/>, 2009.
- [3] R.I. Davis, A. Burns, R.J. Bril, J.J. Lukkien. “Controller Area Network (CAN) Schedulability Analysis: Refuted, Revisited and Revised”. *Real-Time Systems*, Volume 35, Number 3, pp. 239-272, April 2007.
- [4] R.I. Davis, S. Kollmann, V. Pollex, F. Slomka, “Controller Area Network (CAN) Schedulability Analysis with FIFO queues”. In proceedings 23rd Euromicro Conference on Real-Time Systems (ECRTS), pages 45-56, July 2011.
- [5] M. Di Natale, “Evaluating message transmission times in Controller Area Networks without buffer preemption”, In 8th Brazilian Workshop on Real-Time Systems, 2006.
- [6] D.A. Khan, R.J. Bril, N. Navet, “Integrating hardware limitations in CAN schedulability analysis,” IEEE International Workshop on Factory Communication Systems (WFCS) pp.207-210, 18-21 May 2010.
- [7] D.A. Khan, R.I. Davis, N. Navet, “Schedulability Analysis of CAN with Non-abortable Transmission Requests”. In proceedings 16th IEEE International Conference on Emerging Technologies and Factory Automation (ETFA'11), Sept 5-9th, 2011.
- [8] K.W. Tindell, A. Burns. “Guaranteeing message latencies on Controller Area Network (CAN)”, In Proceedings of 1st International CAN Conference, pp. 1-11, September 1994.
- [9] R.I. Davis, N. Navet, “Controller Area Network (CAN) Schedulability Analysis for Messages with Arbitrary Deadlines in FIFO and Work-Conserving Queues”, in submission, 2012.
- [10] P. Meumeu Yoms, D. Bertrand, N. Navet, R.I. Davis, “Controller Area Network (CAN): Response Time Analysis with Offsets”, in submission, 2012.
- [11] A. Monot, N. Navet, B. Bavoux, C. Maxim, “Fine-grained Simulation in the Design of Automotive Communication Systems”, Embedded Real-Time Software and Systems (ERTS 2012), Toulouse, France, February 1-3, 2012.
- [12] N. Navet, “Automotive communication systems: from dependability to security”, talk at the 1st Seminar on Vehicular Communications and Applications (VCA 2011), Luxembourg, May 2011.
- [13] N. Navet, A. Monot, J. Migge, “Frame latency evaluation: when simulation and analysis alone are not enough”, 8th IEEE International Workshop on Factory Communication Systems (WFCS2010), Industry Day, May 19, 2010.
- [14] D. Khan, N. Navet, B. Bavoux, J. Migge, “Aperiodic Traffic in Response Time Analyses with Adjustable Safety Level”, IEEE ETFA2009, Mallorca, Spain, September 22-26, 2009.
- [15] N. Navet, Y-Q. Song, F. Simonot, “Worst-Case Deadline Failure Probability in Real-Time Applications Distributed over CAN (Controller Area Network)”, *Journal of Systems Architecture*, Elsevier Science, vol. 46, n°7, 2000.
- [16] M. Grenier, L. Havet, and N. Navet, “Pushing the limits of CAN-Scheduling frames with offsets provides a major performance boost”, in Proc. of the 4th European Congress Embedded Real Time Software, January 2008.
- [17] R. Saket, N. Navet, “Frame Packing Algorithms for Automotive Applications”, *Journal of Embedded Computing*, vol. 2, n° 1, pp93-102, 2006.

CONNECTORS – MARVELS OF ENGINEERING DESIGN

BILL HENDERSON, INDUSTRY DIRECTOR FOR AEROSPACE AND DEFENCE AT HYPERTAC, PART OF SMITHS CONNECTORS, DISCUSSES THE STRENGTHS OF THE UBIQUITOUS CONNECTOR

The need for the humble connector has been around ever since the first practical experiments in electricity were conducted in the eighteenth century. As with all electronic technologies, the connector has gone through a long and exciting evolution since those early days, from simple single-pole format, carrying a few amps and volts, to multiway, high frequency, high power and signal conditioning assemblies in a bewildering variety of mechanical styles and complexities.

What's In a Connector

The term 'connector' can be used to describe everything from the domestic 13A plug and socket to the highly engineered complex system that links a space shuttle to the control room while on the launch pad. Indeed such is the degree of evolution that it is now possible for a single connector to provide connections simultaneously to many hundreds of cables of differing functions, consisting of many thousands of components and costing thousands of pounds.

The fundamental requirement of all connectors, however, is to make an electrical connection between two separate conductors and to make this a repeatable event. The most common approach is to make a single robust pin, often solid, and apply mechanical pressure to it via a compliant socket to achieve a low resistance connection between the two. There are exceptions to this approach, notably the technology used within micro D connectors, but nevertheless, this general approach still applies to the vast majority of connections used today.

These pins and sockets are held in an insulating material and are combined in various sizes and numbers to form multiway connectors. Although it is these connectors that are most recognisable today, for example the D-Sub or MIL-DTL-38999, it has perhaps been the technologies associated with the socket contact

itself that have been the subject of much invention and experimentation, and it is this that often determines the overall electrical performance of the connector.

Small Scale Marvels

A wide variety of socket contact technologies have been developed ranging from simple fork and blade connectors, most commonly found in domestic or automotive applications, through bifurcated, slotted tubular sockets that are perhaps the most widespread technology for most applications, including the aforementioned D-Sub and MIL-DTL-38999, to specialised designs such as the brush contacts and contact baskets that are marvels of engineering design, often on a very small scale.

As always, each contact technology is a unique blend of engineering compromises, ranging from mating cycles and fretting corrosion resistance through to contact resistance and ease of manufacture. One technology that has perhaps married all the desirable electrical and mechanical characteristics into a single design more than most is the Hyperboloid socket.

The Hyperboloid socket contact is a clever engineering design where the basic socket technology can now be scaled from a contacts diameter as small as 0.3mm with 5-wire baskets used in very high frequency coaxial applications up to 40GHz, to 30mm dia and 75-wire baskets for very high power applications of up to 1000A, 100 times the diameter.

The basic construction of the Hyperboloid socket contact is shown in Figure 1. As the pin contact enters the basket of wires, the wires stretch within their elastic limits making intimate contact all along the length of the pin with a pre-determined compression against the pin, designed for very low contact resistance with the minimum insertion force.

The fundamental characteristics available from this design are retained across the whole range of diameters and offer substantial advantages over the more standard bifurcated socket contact design, which only makes between two and four points of contact. Furthermore, the contact design offers a tremendous opportunity for characteristic optimisation to suit particular applications. For example, the diameter and number of wires used within the hyperboloid cage, together with the length of contact and the angle of twist, can all be varied to optimise insertion force, mating cycle, fretting corrosion resistance and power handling (see Figure 2). In addition, the choice of wire material and plating finish can also be optimised for each application, such as high temperature or high frequency requirements. The fretting corrosion characteristic of this socket contact, vital for reliable operation within harsh environments and subject to extreme levels of vibration, compared with more traditional fork and blade contacts is shown in Figure 3.

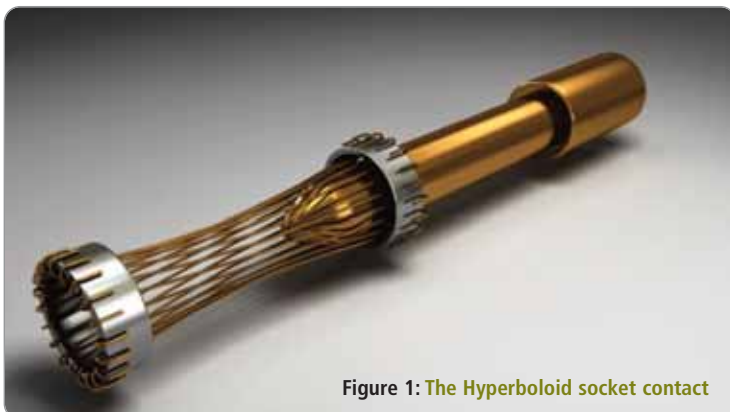

Figure 1: The Hyperboloid socket contact

One Configuration May Fit All

A recent challenge was to determine whether this socket configuration would be suitable to pass the RF signals commonly found in airborne radar systems. High frequency signals are transmitted along coaxial cables of a defined characteristic impedance and any significant change in this impedance along the transmission path results in energy being reflected back towards the transmitter.

Multiple changes can result in multiple reflections and a substantial degradation in overall system performance. The challenges were therefore twofold: (a) to design a contact with a tightly controlled characteristic impedance and excellent RF transmission characteristics, and (b) to design it small enough for the airborne radar application and in keeping with coaxial cable diameters. These challenges resulted in the Hyperboloid once again proving its outstanding capabilities, demonstrating excellent insertion loss and VSWR characteristics up to 26GHz and beyond (see Figure 4).

This high frequency capability also extends to the high-speed digital arena where twinax and quadax contacts are used to transmit Ethernet type signals at gigabit data rates. With similar challenges to be addressed, namely impedance matching, EMI shielding and crosstalk minimisation, twinax and quadax contacts comprise one or two pairs of Hyperboloid sockets within an overall screened socket assembly with diameters, separation distances and arrangements all carefully chosen. This arrangement has been proven to be capable of transmitting data at rates of up to 5GBps and the upper limit of the technology has not yet been reached.

At the other end of the spectrum, the long contact lengths between the pin and socket, and the increased number of contact wires within the socket basket also ensure optimum power transmission with minimum I²R losses. Proven to pass currents as high as 750A in cables with cross sectional areas of 240mm² with 1000A contacts currently under development, the Hyperboloid socket excels in this application, often exceeding the capabilities of other technologies.

Multiple Applications

Of course, the socket contact alone does not make a connector, and today this technology has been incorporated in a wide variety of standard and custom connector shells available from Hypertac to suit multiple applications. The electrical performance of the Hyperboloid socket is well-known in the defence, aerospace, rail and industrial markets for its very high reliability in harsh environments.

It is perhaps best known as the socket contact used within the blue PCB connectors that connect motherboards to daughterboards. What perhaps is less widely known is that the company also provides the very high performance rack-and-panel connectors for applications such as the avionics suite of the Eurofighter aircraft, the high power HBB connectors used in electric and fighting vehicles, as well as heavy duty transponders for the Eurobalise rail system. A wide variety of connectors is available for multiple markets, and these and can be combined today with filtering and transient protection technologies. This enables the connector function to extend from not just reliably and repeatedly joining two conductors together, the challenge at the start of the electrical revolution, to

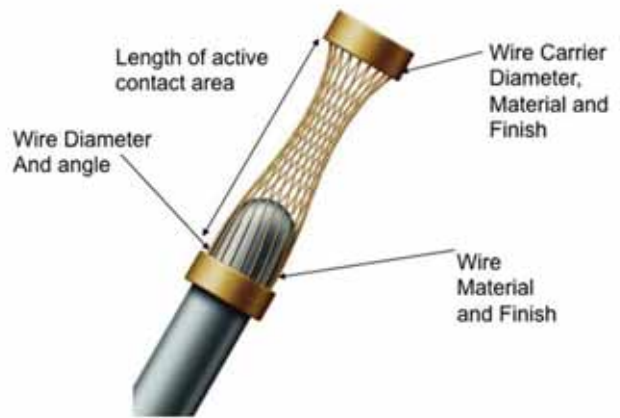

Figure 2: Design parameters of the Hyperboloid socket contact

FRETTING. 50Hz, 1mm amplitude.

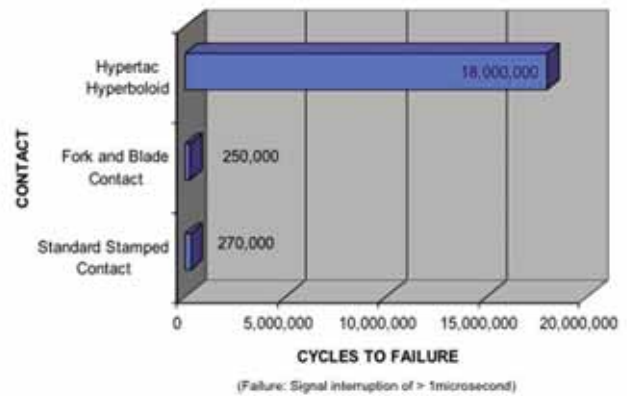

Figure 3: Fretting corrosion characteristic of Hyperboloid contacts

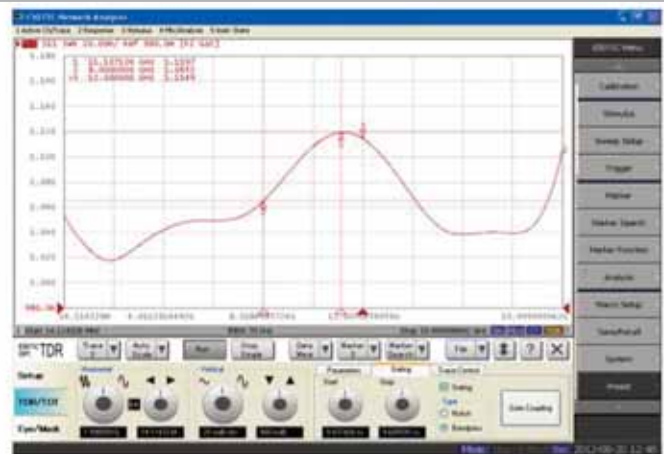

Figure 4: VSWR for a mated pair with Hypertac coaxial sockets for both inner and outer contacts

providing signal conditioning and protection functions required by today's complex systems operating in increasingly polluted electromagnetic environments. ●

CIRCUIT PROTECTION INNOVATION OVER THE YEARS

ROBERT HILTY, SENIOR DIRECTOR OF ENGINEERING OF TE CIRCUIT PROTECTION, CHARTS HIS COMPANY'S HISTORY THROUGH ITS PRODUCTS

The need to protect higher density rechargeable batteries continues to be a key trend in the circuit protection business. When lithium-polymer batteries were introduced in 2008, the technology provided a lot more energy density required for today's portable consumer electronics devices.

When consumers started to migrate from desktop PCs to notebook PCs, computer makers favoured the traditional 18650 lithium-ion cell battery, which was protected by a PPTC-style device. However, the introduction of the Apple iPad and other tablets over the past few years has changed the market dynamics in two ways. It cannibalized the notebook PC market and demanded a new circuit breaker approach to circuit protection in order to ensure a high level of safety for higher power rechargeable lithium-polymer battery packs.

The electronics industry will continue to see a migration to rechargeable lithium-polymer batteries to power these mobile devices. The signs were evident at the 2013 Consumer Electronics Show, where there was high interest in convertible laptops, or dockable tablets. As tablet devices make their way into the enterprise market, and there is broad-based proliferation of the technology, there also will be a shift in battery protection from PPTC-style devices to hybrid solutions that deliver greater protection and longer run times. In addition, there will be a need for significant innovations in emerging high-voltage and high-power applications including those found in automotive, renewable energy and data centre markets.

In the automotive sector, for example, firstly, ongoing electrification in vehicles boosts a need for new circuit

protection devices. Secondly, circuit protection manufacturers will need to address the emerging market for electric vehicles (EVs) and hybrid EVs for vehicle battery safety requirements, as well as battery protection for rapid charging EV chargers. The fast charging capability will have an impact on battery protection needs as current densities and temperature of the batteries increase.

There also has been a resurgence of interest for higher voltage systems in traditional internal combustion vehicles. The 42V or 48V system approach is again under discussion in the automotive industry due to their inherent advantages of reduced power loss, which translates into higher efficiency. However, one of the biggest technological challenges is protecting the cable harnesses from arcing damage. Once a system gets above 24V, arc events become more dangerous and substantial to the point where the arcing will quickly vaporize the connector terminals.

Renewable energy production will have implications for circuit protection in high voltage and power applications, particularly in the area of battery storage. Discussions are also taking place around the potential market for high-voltage DC data centers, to replace traditional AC voltage systems, as a way to reduce energy consumption and costs for cooling data centers.

The voltages and amperages involved surprisingly overlap between data centre needs and renewable energy production, and even hybrid EVs. Applications range between 400 to 750V and hundreds of amps. These applications will drive the need for new protection technologies that provide safe high power disconnections and protect against battery failure.

Overall, higher power requirements, in combination with cost issues and longer life, in all types of electronic devices, ranging from laptops and smart phones to vehicles and renewable energy systems, will drive circuit protection innovation over the next several years. Circuit protection devices will need to handle higher currents, higher voltage and higher discharge rates.

History in The Making

When *Electronics World* launched 100 years ago, the nascent electronic components industry couldn't imagine the innovations that lay ahead that would lead to a global multi-billion dollar business. Circuit protection devices, including circuit breakers and fuses, were already in use by power and industrial companies, thanks in part to Thomas A. Edison's work in power protection.

Fast forward to 1957 and Paul Cook, a pioneer in radiation chemistry research, founded Raychem Corporation, laying the foundation for some of the most significant innovations in circuit protection over the next 50 years. The company would develop the industry's first radiation crosslinked wire & cable for mil/aero applications and heat-shrink tubing. These core technologies, together with other materials science developments, will later yield the industry's first circuit protection devices that automatically reset after a circuit's faults are cleared. Today, billions of these devices can be found in everything from smart phones to dishwashing machines.

TE Circuit Protection's history of materials science innovations began with Raychem's radiation crosslinking technology used in polymer compounds for wire & cable and heat-shrink tubing. Radiation crosslinking technology allows specific polymers, exposed to radiation, to exhibit higher strength and resistance to abrasion, solvents and harsh environments.

Cook's work in radiation chemistry will filter throughout the electronics industry, improving the performance of electronic components and electrical insulation, linking Raychem's first commercial products introduced over 50 years ago to today's PolySwitch polymeric positive temperature coefficient (PPTC) protection devices.

Raychem, acquired by TE Connectivity in 1999, invented PPTC protection technology over 30 years ago – one of Raychem's most

The need to protect higher density rechargeable batteries continues to be a key trend in the circuit protection business

Figure 1: Circuit protection devices from TE Connectivity



important contributions to the circuit protection industry. The fundamental formulation for the carbon-filled, resettable PolySwitch PPTC protection devices came from a conductive polymer product developed for pipe heating in water bed heaters. This won't be the first, or the last time, that TE Circuit Protection's engineers experienced inspiration from unusual sources.

The first PPTC device, introduced in 1980, was used to protect telecommunications central offices from damage due to accidental connection of a phone line to a power line. This was the first time a telecom over-current protection device could reset itself, eliminating the need to send out technicians to replace fuses and line feed resistors.

The Advent of Portable Power

As rechargeable battery technologies, nickel-cadmium, nickel-metal hydride, lithium ion and lithium polymer were introduced and portable electronic devices started to proliferate, Raychem, now called TE Circuit Protection, adapted its technology to portable power protection. The company led the industry to develop protection devices and safety standards needed as a result of increasing energy density and power requirements. These battery protection devices provide safety in the event of over-current or over-temperature conditions caused by either short circuits or potentially dangerous thermal runaway.

After the initial product launch, TE Circuit Protection developed low-voltage PPTC parts for a variety of electronics applications. Several of the first devices were used for primary lithium batteries. A standard surface-mount device (SMD) was developed in the early computer days for PCI and SCSI port protection.

In 1995, the company developed the first miniSMD PPTC device, in an 1812 package size, which was smaller and less expensive than the original standard SMD. They were primarily used for keyboard and mouse protection. Demand for these protection devices started to take off in the late 1990s as the computer industry started to adopt the universal serial bus (USB) ports in computers.

In the 1990s, the commercialization of lithium-ion battery technology was enabled by circuit protection device manufacturers who safely incorporate protection devices in the cells to help ensure that the battery packs didn't catch on fire and hurt consumers.

Meeting the Consumer Preferences

Computers and other electronic gadgets started to shrink in size so electronic components, including circuit protection devices, also needed to be smaller, while helping improve battery performance. To save board space, TE Circuit Protection extended the PPTC range in 1999 with the introduction of the reduced size device in a 1210 package size. As smaller, lighter and higher density lithium-ion batteries were being developed to meet miniaturization demands, TE Circuit Protection's engineers found that taking a materials

science approach would help them develop next-generation products. Two of the newest innovations are the Low Rho PPTC and the metal hybrid protector (MHP) devices, built on the foundation of materials expertise started by Paul Cook's work in radiation chemistry. The first Low Rho PPTC was introduced in 2005 for cellphone battery packs. By changing the formula for the materials, a lower resistance was achieved allowed the battery pack to last longer, thus increase talk time.

This line was extended in 2012 with the introduction of the Low Rho SMD device. TE Circuit Protection's engineers working on this product line drew inspiration from another company that faced the challenge of developing a new coating for a beer bottle that would maintain low oxygen levels. The new Low Rho devices use a new oxygen barrier coating to deliver significantly lower resistance, making battery pack designers very happy as they were able to deliver both longer talk times and greater functionality to their customers. Simultaneously, work was carried out on protection technologies to address higher power Li-ion batteries that were also smaller and lighter. This required a technology that was robust enough to deliver improved battery safety, particularly at a time when the US Consumer Product Safety Commission announced several large recalls of laptop batteries, which could potentially overheat and cause a fire.

As such the low resistance PPTC device was combined with a bimetal breaker to develop the resettable MHP. The combination helps prevent arcing at higher currents, above 30Vdc, 30A. The first MHP device was designed for high-rate-discharge lithium batteries used in products such as cordless power tools, back-up power supplies and e-bikes. The company later expanded the product line with the miniature resettable MHP with Thermal Activation (MHP-TA) to protect lithium-polymer batteries used in tablets, ultra-thin PCs, e-readers and other mobile devices. These protection devices target lower voltage and current rating applications.

Future Innovations

As the electronic components industry faces new challenges, TE Connectivity will continue to innovate, building on the foundation of Paul Cook's legacy of inventing new materials and combining them with electro-mechanical technologies to meet even more challenging circuit protection requirements in the future. ●

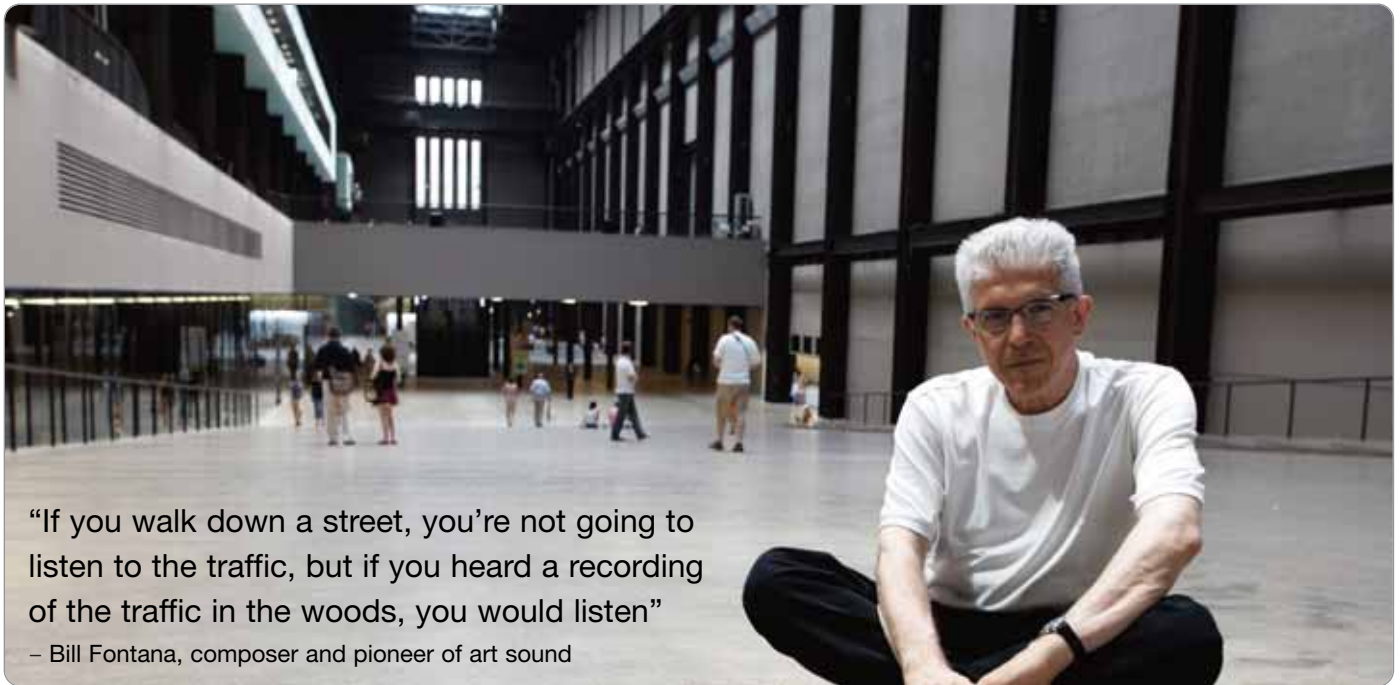

“If you walk down a street, you’re not going to listen to the traffic, but if you heard a recording of the traffic in the woods, you would listen”

– Bill Fontana, composer and pioneer of art sound

RELEASING THE MUSIC IN THE GOLDEN GATE BRIDGE

MAKING SOUND ART WITH ACCELEROMETERS, CHARGE AMPLIFIERS AND MICROPHONES, **BILL FONTANA** ENHANCES OUR PERCEPTION OF SOUNDS BY REVEALING HOW STRUCTURES HUM WITH AN UNSEEN RHYTHM

Using accelerometers, microphones, speakers and amplifiers for uses their designers surely never foresaw, Bill Fontana has been making sound art since the 1970s. Trained as a composer, he soon found an interest in the physics of sound and in the music inherent in the sounds of everyday life. He now develops music that uses sounds created with technological means. His innovative vision has become internationally renowned through critically-acclaimed installations all around the world. Big Ben, the Brooklyn Bridge and the Arc de Triomphe are just some of the well-known structures to have had their pulses felt by Fontana as he sets out to show us the music that exists within both structures and everyday sounds.

In 2006, London’s Millennium Bridge became the focus of Fontana’s work, when he worked alongside the bridge’s builders – Arup Engineering – to place Brüel & Kjær accelerometers all over the structure. Entitled *‘Harmonic Bridge’*, Fontana’s work used the way the bridge’s unique, flexible structure oscillated and vibrated in its many different modes to create an enormous musical instrument. Next to the bridge stands the monolithic Tate Modern art gallery and there, in the enormous Turbine Hall, the accelerometer signals were replayed as audio output – after

judicious tweaking with a digital signal processor (DSP). The effect thrilled its creator and visitors alike.

“It made beautiful sounds with the wind,” says Fontana, “With people walking, the fact it had previously had problems with its structural dynamics, just made it more interesting.”

“The bridge was alive with vibrations caused by its responses to the collective energies of footsteps, vibrations and wind,” he



Accelerometers help transcend the limitations of time and space, providing listeners with a sound of Big Ben like none they have heard before

says. “You can’t normally hear it, but it’s revealed by accelerometers placed all over the bridge to map in real time its hidden musical life.”

This live, sonic mapping was then translated into a ‘living’ sculpture by rendering sounds into a spatial matrix of loudspeakers, with the goal of showing what’s already there rather than altering the sound too much. As he says, “It’s more like I’m bringing something that’s alive out into the world, and the less of me and the more of it, the better.”

Sonic Vision

Perhaps the inner life of structures is an unusual choice for a musician, but for Fontana it was something of a logical progression from an early interest in the sounds we hear every day. “Hearing sounds around me became as interesting and beautiful as listening to music. I came to regard the act of listening as a creative activity – finding music in the environment around me,” he says.

But it is not just about good vibrations, as studio microphones and hydrophones have played important parts in most of his works. In his 2010 work *‘River Soundings’*, he took sounds from the River Thames and played them inside London’s nearby cultural centre Somerset House. And on another occasion he filled the rotunda of the San Francisco City Hall with a mixture of mid-range sounds like birds, trams and water, using ultrasonic emitters to beam them around with great accuracy, and making people appreciate them in a whole new way.

“With accelerometers you can discover the inner life of structures, and that is really what interests me and what my work is about,” says Fontana. “All the solid things you see, all those materials, if you could ‘enter’ them, you could see they are actually vibrating within themselves. So I’m interested in entering into that dimension of materiality.”

There are many temples in Kyoto where some enormous, 1000-year-old bells drew his attention. “I was interested to see if they make any sounds when they are not ringing,” he says.

Attaching accelerometers with beeswax revealed that they are in fact vibrating all the time. “It’s actually an elastic material that reacts to the sound energy of the garden around it. It’s not a sound you can hear standing next to it, so for all you know it’s silent, but put on an accelerometer and you enter a hidden world.”

“I regard sound as vibration in any solid material – be it water or solid,” he continues, “so I am trying to get inside the structure to look at that inner world. To me, the accelerometer is a very important tool and my favourite one is a Brüel & Kjær charge amplifier: The front panel is so precise that it is possible to very accurately alter the sound in very fine adjustments. You have a great deal of control.”

If you think of the sound of Big Ben, the bell rings when you stand next to it. So is that the ‘right’ sound of the object?

“I generally use piezoelectric accelerometers for live installations”

– Bill Fontana

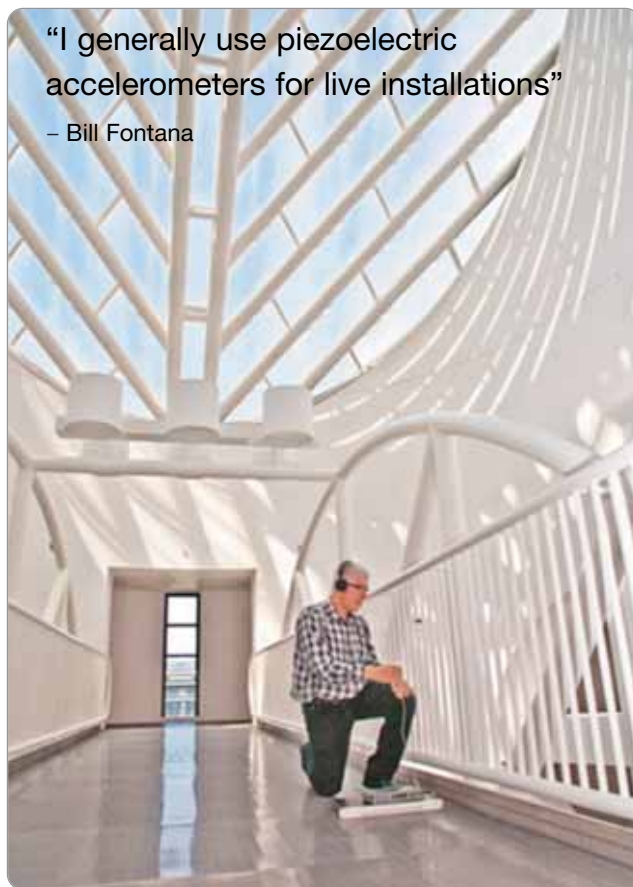

The Golden Gate Bridge

In celebration of its 75th anniversary, one of Fontana’s largest projects was wiring up San Francisco’s Golden Gate Bridge with accelerometers, and when his installation opened in May 2012, it was in fact Fontana’s second project featuring the famous bridge. The first, in 1981, was a live replay of sounds like deep, booming foghorns from different parts of the bridge, as well as a nearby seabird refuge. This time though, he was more interested in the vibrations. “I really wanted to release that inner sound. I climbed all over the bridge with some signal analyzers and had fun testing it for the installation. It’s a live structure and tapping into that is very exciting. Putting an accelerometer on either side of an expansion joint on the bridge sounds great, it almost chimes.”

Using Technology to Create Art

“My favourite product is a charge amplifier,” says Fontana. “It runs on batteries when necessary, and I like that when you connect a charge accelerometer to it you have so much control over the accelerometers.”

Fontana’s Brüel & Kjær type 2635 charge amplifier stands out from his other equipment, due to the great control it gives over the received signal. With input from transducers like accelerometers or hydrophones, and an audio output, it can connect structures to a variety of transducers.

Over the years, Brüel & Kjær equipment has made an appearance in most of Fontana’s projects. He has also used Brüel & Kjær hydrophones, types 8103 and 8104, as well as type 4006 studio microphones bought in 1991. “When making initial field recordings and site surveys, I use the charge amplifier with a charge accelerometer like the type 4379,” says Fontana, “However, I generally use piezoelectric accelerometers for live installations.”



Accelerometers on London's Millennium Bridge track its dynamic vibrations (above) – and replay them as sound in the adjacent Tate Modern gallery (below)



Discombobulating The Non-Listeners

We all learn to listen conditionally. We categorise sounds into unwanted 'noise' and desirable music – and many categories in-between. Unwanted sounds – which are the most of – we 'zone out', and for Fontana, this is not necessarily a good skill to have.

"I think our culture is in many ways acoustically illiterate, in that people don't grow up learning and recognising, or even paying attention to, sound patterns in what they would call noise," he adds.

For Fontana, eliciting insights in people's acoustic perceptions is the goal, and dislocation is a great way to achieve it. "We learn not to listen by visual cues. If you walk down a street, you're not

going to listen to the traffic, but if you heard a recording of the traffic in the woods, you would listen. So the eyes can switch off the ears, and I like to defeat that mechanism." As such, his projects are experiments in perception, designed to break down the general habits of 'non-listening'.

Fontana's own artistic hero is the legendary avant-garde composer John Cage, famed for the instrument-free composition "4'33". Cage once said: "Music is continuous and only stops when we turn away and stop listening." In other words, if a tree falls over in the woods and there is no-one to hear it, it not only still makes a sound, but it makes an interesting and possibly a musical one.

The True Nature Of A Sound

"A sound is all the ways there are to hear it" is a quote often ascribed to Fontana, and if you find that confusing then fear not, for he is a man who likes to use concrete examples to illustrate the

concepts he wants to convey.

"I did a project in London in 2008 called '*Speeds of Time*' that illustrates this idea," he says. "If you think of the sound of Big Ben, the bell rings when you stand next to it. So is that the 'right' sound of the object? But then, what if you go on the rooftop, is that the right sound? What about if you are 1000 feet away and the delay affects the sound, is that the right sound? What's the correct sound, and what's the correct time?"

"I want to show a composite of the sound from all these different ways there are to hear it. Showing these things all at the same time is the real sound of the bell, which is possible through the use of technology."

Another example was when he installed microphones at a series of railway level crossings. Trains have to blow their air-horns before they cross them, so he was able to record the effects of Doppler shift as the trains approached and left the crossings, with the pitch rising and falling.

"Hearing these all together gave a really interesting harmonica effect," he says, "and it was only possible through the technology – since we don't have an octopus-like array of ears to hear all the sounds at different locations simultaneously."

Future Ideas

The huge and complex structures of bridges hold a strong attraction for Fontana, and once the Golden Gate Bridge has finished giving up its secret sounds, he won't be finished with them by a long shot.

"I read in the New York Times about a bridge that is being rebuilt – the Bay Bridge in San Francisco," says Fontana. "This bridge is designed to sway in an earthquake, which sounds really interesting, so I might start looking at that."

Fontana's next great creation opens in Glasgow on 18 April. Called '*Silent Echoes*', the project will dust off the enormous Finniestone crane and bring it back to life, in a wholly different way from its industrial heyday.

Further down the line Fontana is set to become artist in residence at CERN – the world's largest particle physics laboratory in Geneva. Beginning in June 2013, the exhibition is rumoured to include time-travelling sound.

Might it be possible to hear a Higgs Boson particle? ●

Bit for Bit – Fast, Certain, Reliable



A perfect alliance.

As a specialist for innovative connection systems,
we have the right solution for your most difficult requirements.



- Transmission rates up to 10Gbit/s
- Up to 5,000 mating cycles
- Compliance with the established standards, such as IEC11801 for Ethernet

- Various data protocols possible such as Ethernet, Firewire, USB and many others
- Outstanding return loss

ODU-UK Ltd
Phone: 01509/26 64 33
sales@odu-uk.co.uk

networking THE **1** DAY seminar EVENT Industry dinner

ELECTRONICS
SOURCING
LIVE

16 May 2013
Stadiummk • Milton Keynes

MORE INFORMATION
sales@es-live.co.uk
01892 613400



At ES LIVE
you will find:
What to Buy
Where to Buy
How to Buy

**The one day networking event
for the electronics industry**

FREE Entry

FREE Parking

FREE Refreshments

- ⌚ Thursday 16th May 2013
 - 📍 Held at the Double Tree by Hilton Milton Keynes, Stadiummk MK1 1QB
 - Exhibition open 10.00am - 4.00pm
 - FREE Seminars & Workshops
 - Networking Gala Dinner 7.00pm - late
- Ticketed event

**REGISTER
NOW**

www.es-live.co.uk

THE END OF THE ROAD?

DO EXPERIMENTAL RESULTS MEAN THE END OF THE ROAD FOR WHAT HAS BEEN TAUGHT TO 14-YEAR-OLDS THROUGHOUT THE WORLD FOR 150 YEARS, WHICH IS A “STEADY CHARGED CAPACITOR” HAS STATIC ELECTRIC FIELD BETWEEN THE TWO PLATES? BY IVOR CATT

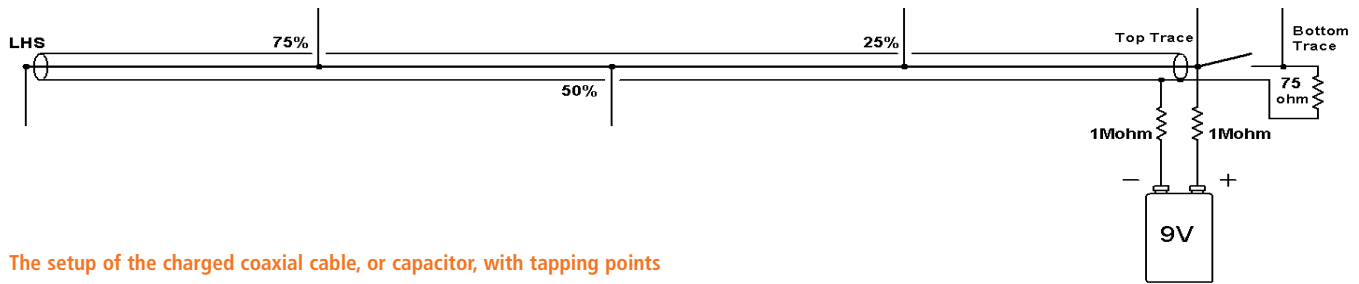

A capacitor, made of 50 ohm coaxial cable, is slowly charged up to 8V from a voltage supply via a large resistor. It is then suddenly discharged by closure of a reed relay into a long 50-ohm cable. According to the Instruction Manual for the Type 109 pulse generator (GR) from Tektronix, the result is a double length, half-amplitude pulse.

On page 2, the manual states: “The output pulse duration is equal to twice the transit time of the charge line used, plus a small built-in charge time due to the lead length from the GR panel connectors to the mercury [reed relay] switch contact point.”

“The transit time of the cable is defined as the time required for a signal to pass from one end of the line to the other. For a 10ns charge line then the duration of the output pulse would be 20ns. The pulse amplitude obtained will be approximately one-half the power source voltage...”

It seems that since I used it 49 years ago in 1964, nobody else has pondered the significance of the half-size double-length pulse. The final part of the energy must have waited for twice the delay time from end to end of the capacitor before exiting. In 1980 this led to me propounding: “This paradox, that when the switches are closed, energy current promptly rushes away from the path made available, is understandable if one postulates that a steady charged

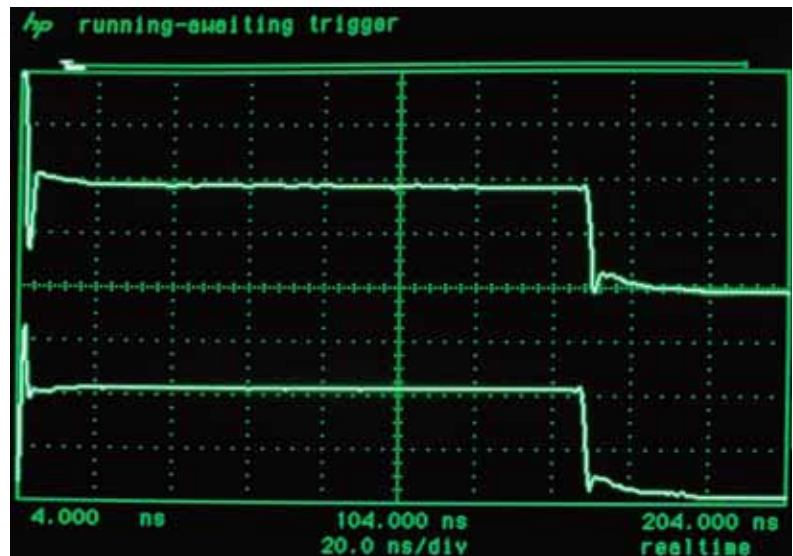

Figure 1: Bottom Trace: The bottom trace probe is across the 75Ω terminator used as a trigger. It shows a pulse of the half battery voltage (actually 8V after the 2 x 1MΩ resistors and the probe loading); **Top trace:** Left-hand side of the reed switch. The trace immediately drops from 8V to 4V

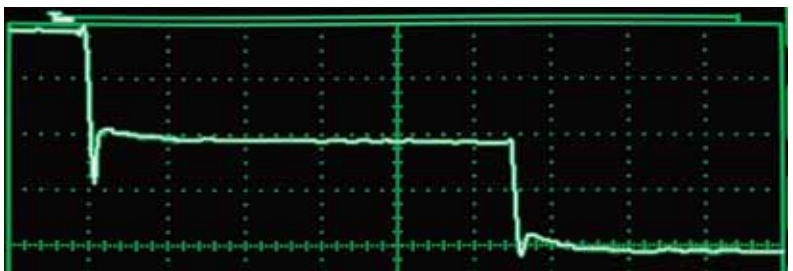

Figure 2: 25% to the left of the reed switch (4.5m)

capacitor is not steady at all; it contains energy current, half of it travelling to the right at the speed of light, and the other half travelling to the left at the speed of light.

Now it becomes obvious that when the switches are closed, the rightward-travelling energy current will exit first, immediately followed by the leftward-travelling energy current, after it has bounced off the open circuit at A.

We are driving toward the principle that Energy (current) $E \times H$ cannot stand still; it can only travel at the speed of light. Any apparently steady field is a combination of two energy currents travelling in opposite directions at the speed of light. E and H always travel together in fixed proportion Z_0 ." – *"Death of Electric Current"*, *Wireless World*, December 1980, page 79.

An Historic Experiment

On 5 June 2009 I belatedly realised that we could do an historic experiment. It was to set up a Tek109 pulse generator with a 40ns charging line, but introduce monitor points every 10ns along the line into a sampling scope. We would then see the clean way in which the charged voltage, say 8V, drops to 4V at the appropriate moment when the first part of the output pulse has outputted to the right but the second part, travelling in the opposite direction is not present. That is, first of all we would see 8V and then for a period we would see 4V, then 0V.

The 'establishment' would have to resist the obvious conclusion, that before the reed relay was closed, half of the energy in the cable was already travelling to the right and the other half to the left. Nothing was ever stationary.

My colleague Forrest Bishop and I had bought four Tektronix 109 pulse generators, and matters had drifted for three years.

There were considerable problems in getting the necessary equipment together. Finally, after three frustrating

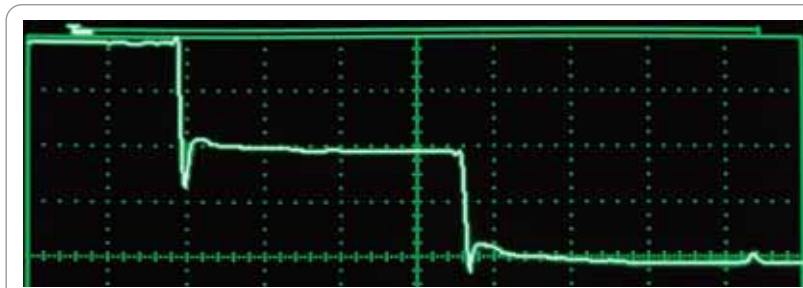

Figure 3: 50% to the left of the reed switch

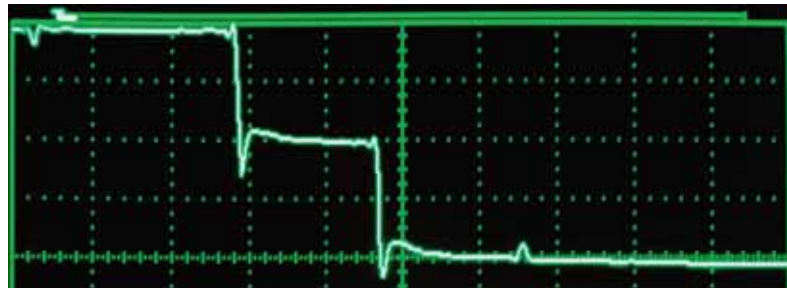

Figure 4: 75% to the left of the reed switch

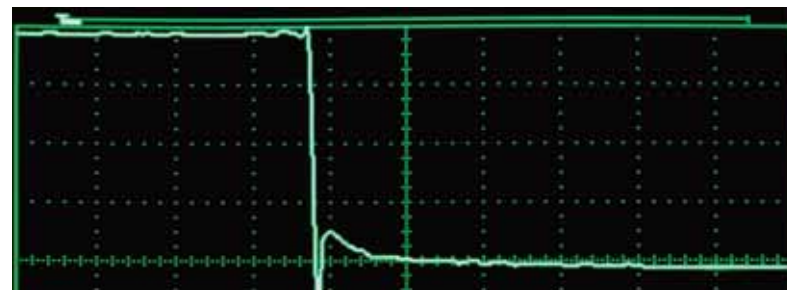

Figure 5: At extreme left of the unterminated end of the coax

It seems that nobody else has pondered the significance of the half size double length pulse

years, Tony Wakefield of Melbourne succeeded, and we here present the results. Wakefield happened to have a newer type of oscilloscope that could register a one-shot with a response of 2ns, and as such he did not need the Tektronix pulse generator. Within a few days he had done the experiment and delivered his results.

We now have experimental proof that the so-called steady charged capacitor is not steady at all. Half the energy in a charged capacitor is always travelling

from right to left at the speed of light, and the other half from left to right.

The Wakefield experiment uses a 75-ohm coax 18 meters long. The left-hand end is open circuit. The right-hand end is connected to a small, 1cm long, normally-open reed switch. On the far side of the reed switch is a 75-ohm termination resistor simulating an infinitely long coaxial cable. A handheld magnet is used to operate the switch.

The coax is charged from a 9V battery via 2×1 megohm resistors, close-coupled at the switch to centre and ground. The two resistors are used to isolate the relatively long battery wires from the coax. High value resistors are used to minimize any trickle charge after the switch is closed.

A 2-channel HP 54510B digital sampling scope set to 2V/div vertical and 20ns/div horizontal is used to capture

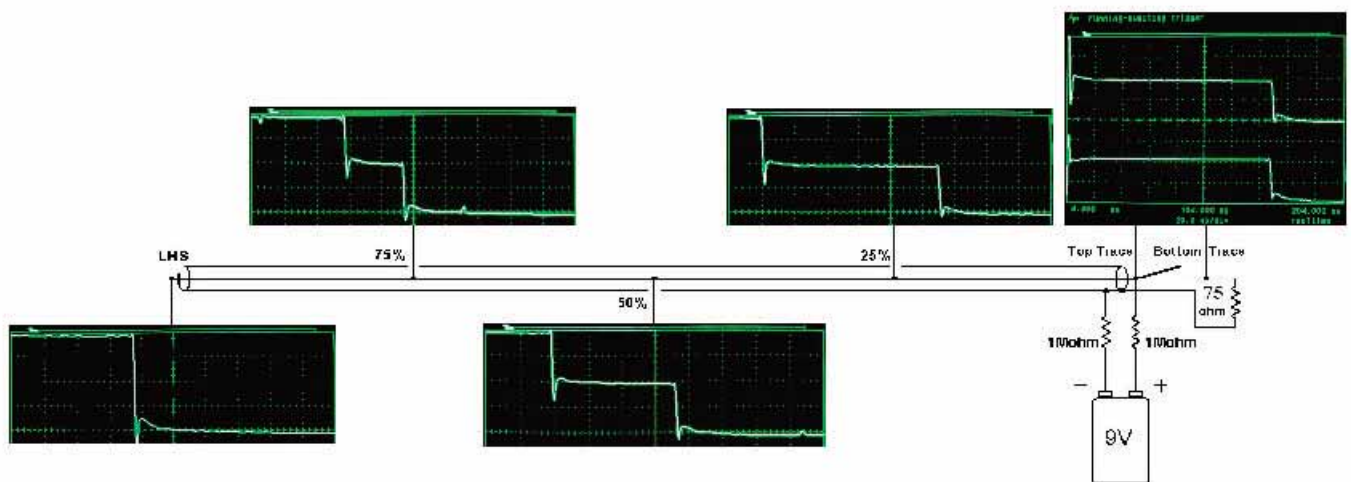

Figure 6: Waveforms seen at relevant points in the charged cable

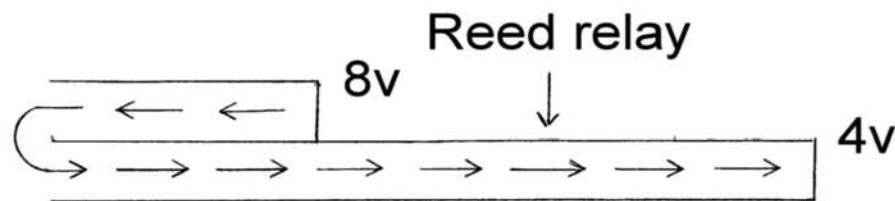

Figure 7: Snapshot of the cable when one quarter of the pulse has left the capacitor

five images:

1. The bottom trace probe is across the 75-ohm terminator used as a trigger. It shows a pulse half the battery's voltage (actually 8V after the 2×1 megaohm resistors and the probe loading). Top trace: left-hand side of the reed switch. The trace immediately drops from 8V to 4V.
2. 25% to the left of the reed switch (4.5m).
3. 50% to the left of the reed switch (9m).
4. 75% to the left of the reed switch (13.5m).
5. At the extreme left of the unterminated end of the coax.

A Change In Theory

In my article entitled “Displacement Current” in *Wireless World* in December 1978 I pointed out that when a battery charges a capacitor, the energy is introduced into the capacitor at the speed of light. Once inside the capacitor, there is no mechanism for the energy to slow down.

The change in theory for a charged capacitor from stationary electric field to two electromagnetic fields travelling at the speed of light is an introduction to my general theory, that there is no such thing as a stationary field, electric or

magnetic. Not only in the case of a charged capacitor, but always, any apparently stationary electric or magnetic field is in fact the superposition of two $E \times H$ electromagnetic fields travelling in opposite directions. Occam's Razor supports this assertion. In the case of the charged capacitor, the two magnetic fields are equal and opposite. They cancel, so an instrument cannot detect them. This gives the impression that a charged capacitor only has electric field, although the energy delivered to it when charging is a TEM wave of $E \times H$ energy current. The delivered energy is conventionally said to have half its energy in the electric field and half in its magnetic field, travelling at the speed of light.

In *Electronics World*, January 2011, page 20, I again proved from first principles that such a TEM wave can only travel at the speed of light for the dielectric, $\pm 1/\sqrt{\mu\epsilon}$. It cannot travel slower. In our case the only possible velocity remains c , because it should be well known that when two pulses travel through each other in a coaxial cable they do not slow down. Rather, I^2R losses disappear. ●

ONGOING DOUBTS

ALTHOUGH MY COLLEAGUE FORREST BISHOP ARGUES THAT SURELY SOMEONE ELSE WILL ALREADY HAVE THOUGHT OF TAPPING INTO THE CHARGED PIECE OF COAXIAL CABLE TO SEE WHAT HAPPENS DURING DISCHARGE, I DOUBT IT. After all, it was only after more than 40 years

that the idea occurred to me. Also, it somewhat contradicts Forrest's other point, that long ago he realised the level of competence among those with accreditation in electromagnetic theory – professors and textbook writers – is far lower than I would have imagined until recently. They are lost in a cloud of dubious mathematics and early 20th century delusions including wave-particle dualism, also using Fourier to ignore anything other than sine waves, and so lack grasp of the physics of a TEM pulse.

ABOUT BULGIN

Bulgin is one of the electronics industry's longest-running success stories - familiar and trusted worldwide. As part of the Elektron Technology Group, Bulgin has a proud heritage of product engineering, and has been designing and manufacturing environmentally sealed electromechanical components for power connectivity and circuit protection for over 80 years. Bulgin pioneered IP68 rated connectors, providing fast and efficient environmental protection in the harshest environments.

Drawing on its expertise, experience, flexibility and innovation, Bulgin provides off-the-shelf and bespoke functional products that can substantially reduce development time and production costs for its customers. Its Buccaneer range of rugged dust and waterproof circular connectors are still the first choice of engineers looking for fast, secure and safe connections in harsh or hostile conditions. The latest addition to the range, the Buccaneer 6000 Series, features a unique and easy to use, patent pending pushpull locking system that offers more rapid connections than a traditional screw thread mechanism, making it easier than ever before to create a robust,



environmentally-sealed interface.

Bulgin stays ahead by continuing to offer new products in response to market needs. In an 'always on' world, there is an increasing trend towards modular equipment designs to allow on-site assembly or replacement of easily exchangeable parts. This approach helps to increase flexibility while reducing costs and downtime.

Bulgin products are everywhere and, despite their unassuming appearance and often hidden nature, they play a key role in an enormous variety of applications that present unique challenges and require outstanding performance and reliability. The broad range of applications includes:



- Agricultural and horticultural installations
- Broadcasting
- Energy production
- Factory automation
- Food processing
- Industrial machinery
- Lighting
- Motorsport
- Safety testing
- Specialist vehicles



Explore the simplest way to
IEEE 1588 Precision Timing!

OTMC 100i Antenna-integrated PTP Grandmaster Clock

- PTP Grandmaster Clock & NTP Time Server integrated in the antenna housing
- Powered over Ethernet
- Secure web interface
- Extremely low power consumption

More at: www.omicron-lab.com/otmc-ew



OMICRON
LAB

THE CHALLENGES OF USING CONFLICT-FREE MINERALS IN THE ELECTRONICS INDUSTRY

KAREN MASCARENHAS REPORTS ON THE ISSUE OF CONFLICT-FREE MINERAL SOURCING WITHIN THE ELECTRONICS INDUSTRY

On Tuesday 29th January 2012, Bill Gates gave a memorable Richard Dimbleby lecture at the Royal Institute in London. Arguably one of the greatest entrepreneurs in history – and certainly one of the world’s mightiest philanthropists – Gates’s speech was not so much breathtaking as it was full of good sense and endeavour.

He spoke of how technological developments can help humankind with particular reference to his current, massive undertaking – the eradication of polio worldwide. He graphically indicated precisely how the evolution of technology can help, by showing the audience a massive lung machine (now a museum piece), which had been used to help children with polio to breathe, and then by contrast, held his hand up with a small vial of the polio vaccine.

Equally, technology can play a vital part in the fight against the use of conflict minerals – minerals that are mined within areas of armed conflict.

Materials for the Electronics Industry

There are many materials the electronics industry uses and among them four important ones, mined in a war-torn region of the Democratic Republic of Congo (DRC). These are the so-called “3Ts and Gold”, or simply 3TG, and include:

- **Coltan**, or Columbite-tantalite, which is a metal ore from which tantalum is extracted. Its primary use is in the electronics industry, in the manufacture of high-performance capacitors used in mobile phones, laptops, video game consoles, video and digital cameras, as well as in medical applications such as heart pace-makers and hearing aids. Furthermore, in its carbide form tantalum is extremely hardwearing and is ideal for jet engine turbine blades, drill bits and other tooling.
- **Cassiterite**, which is the principal ore for the production of tin, and is vital in the electronics industry for soldering circuit boards.
- **Wolframite**, which is the source of the element tungsten. Tungsten carbide, like tantalum carbide, is extremely hardwearing, and is the material of choice used within mobile phones for the vibration mechanism.
- **Gold**, amongst other uses, is present in some of the chemical compounds used within certain semiconductor manufacturing processes.

Sadly, these minerals are largely mined by slave labour, coerced into working in terrible conditions by numerous rebel groups, including the Congolese National Army and the Democratic Forces for the Liberation of Rwanda (FDLR). These wars have spilled over into neighbouring Uganda, Rwanda and Burundi. A recent study by the International Peace Information Service (IPIS) suggests that at present more than 50% of mining



Figure 1: Bagged and tagged conflict-free tantalum ore
[Courtesy of AVX Corporation]



Figure 2: Ore before crushing and sampling
[Courtesy of AVX Corporation]

sites in the DRC are run by armed groups who kidnap civilians, often children, to provide the slave labour. The Democratic Republic of Congo has been embroiled in conflicts for more than a century – based primarily on the rush to plunder its natural

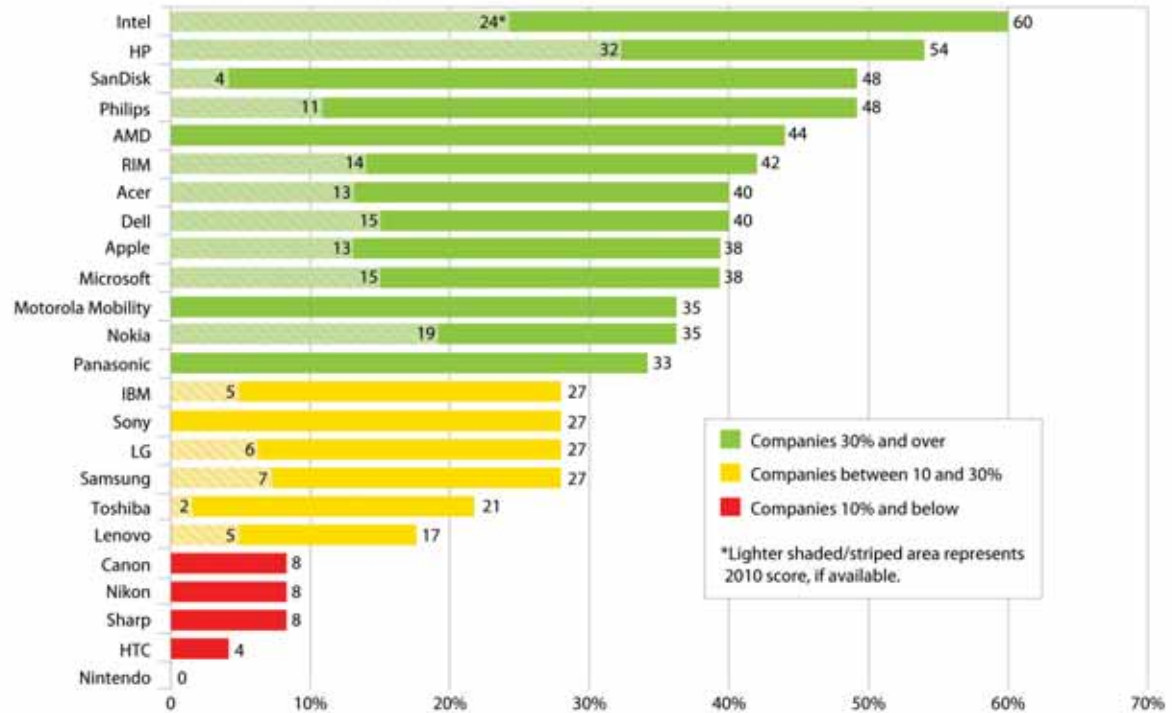

Figure 3: Percentage of progress toward responsible sourcing on conflict minerals
[Credit: Enough Project]

resources. These conflicts have escalated in recent years with an estimated cost of 5.4 million lives and displacement of 2 million people – the highest figures since World War II.

US Legislation

Senator Sam Brownback, in April 2009, introduced the Congo Conflict Minerals Act of 2009, requiring electronics companies to verify and disclose their sources of cassiterite, wolframite and tantalum. This legislation did not get beyond the committee stage.

However, in August 2009, following a visit to the Eastern Region of Congo, Secretary of State Hillary Clinton said that the world needs to do more “to prevent the mineral wealth from the DRC ending up in the hands of those who fund the violence”.

Toward this goal, the US Congress passed the Frank Wall Street Reform and Consumer Protection Act, signed in law by President Barack Obama on the 21st July 2010.

Robust draft regulations to implement the Conflict Mineral Law were issued by the US Securities and Exchange Commission (SEC) and published in the Federal Register on the 23rd December 2010, which would require US and certain foreign companies to report and make public the use of “Conflict Minerals” from the Democratic Republic of Congo (DRC) or adjoining countries.

Nancy McMillan,
a geologist at New Mexico State University who has worked on LIBS for a decade, is optimistic about the LIBS mechanism for geochemical fingerprinting

In less than 18 months, any publicly-traded US component manufacturer must disclose their usage of conflict minerals to the federal government. The issue is highly complex, whereby companies would have to furnish data, declarations or documentation to fulfil regulatory requirements outlining the presence of such minerals in their supply chain. Under the terms of the SEC ruling, the companies must also disclose what measures have been undertaken to minimise their use of raw materials which contribute to human atrocities in the DRC and neighbouring countries.

It is worth putting the monetary part of this matter into context. When, for example, the Dodd-Frank legislation was initially signed in 2010, every smart phone contained tantalum with a value equivalent to approximately \$0.15 and in 2012 this would amount to an estimated \$93m – and that’s for smart phone applications alone.

Using Technology As A Solution

One important way to fight against using minerals mined in war-torn zones is to identify their origins, and such solutions are emerging already. Richard Hark, for example, chemistry professor at Juniata College in Huntingdon, Pennsylvania, has developed a method based on laser-induced breakdown spectroscopy (LIBS) that provides a geochemical ‘fingerprint’ for such minerals. LIBS is able to generate these ‘fingerprints’ with a laser-induced plasma that breaks down samples into atoms; once excited they emit light at specific wavelengths. The resulting spectrum can contain thousands of spectral lines, used with pattern recognition and statistical methods to tease out subtle differences between samples. The potential for this analysis makes it a viable and practical way to differentiate between mining locations and ownership.

Nancy McMillan, a geologist at New Mexico State University who has worked on LIBS for a decade, is optimistic about the LIBS mechanism for geochemical fingerprinting.

**Verified
tantalum material has been
used in AVX's general SMD
tantalum capacitor products
since January 2013**

Delivering Conflict-Free Minerals

With this substantial progress in using scientific methods to verify the origins of minerals, it is now up to the companies involved to develop their strategies for sourcing and manufacturing their products without the use of conflict minerals.

The “*Solutions for Hope*” project was launched by Motorola in July 2011 in partnership with AVX, Hewlett-Packard, Robert Bosch, Intel and other companies to provide a ‘closed-pipe’ pilot process for delivering conflict-free tantalum from the DRC in accordance with OECD due diligence guidelines. Since December 2011, AVX has exclusively sourced tantalum powder and wire from smelters who comply with the Electronic Industry Code of Conduct (EICC) and the Global e-Sustainability Initiative (GeSI) Conflict-Free Smelter program.

By minimising the processes involved to validate the ‘closed pipe’ operation, the value of the DRC tantalum raw material can remain in the DRC for the benefit of the local people. This project offers hope to desperately poor artisanal miners and their families. Inadvertently,

many of these miners have suffered from the unintentional consequences of a de facto embargo within the non-conflict regions of Katanga as a result of the Dodd-Frank Act in the US.

The ‘closed pipe’ principle applied to tantalite ore, mined from a single approved site within Katanga Province of the DRC, which is then traced along a secure closed supply chain to the end customer’s electronic equipment.

Verified tantalum material has been used in AVX’s general SMD tantalum capacitor products since January 2013.

Everyone Has a Part to Play

During the Dimpleby lecture mentioned earlier, Bill Gates spoke of the number of people involved in his polio-eradication project – scientists, doctors, nurses, and operational and logistics management staff using the latest software systems. With 75,000 children born each day, one can envisage the uphill task of the vaccination project and, yet, Gates is undaunted and optimistic. Only three countries in the world now have cases of polio – Nigeria, Pakistan and Afghanistan.

What can we in the electronics industry learn from Gates? We can all play our part in the eradication of conflict minerals in electronics products: the manufacturers, of course, the distribution companies, the legislators, editors who have access to the CEOs and MDs of companies – asking each what measures their companies are implementing, and last but not least – we, the consumers. As in the diamond industry or with Fair Trade, we consumers, in our endless quest for the latest electronic technologies, can ask that our mobile phones, laptops and other equipment should state on the front of the product: “Manufactured Using Conflict-Free Minerals”! ●





The new Bulgin 6000 Series connector

Robust, instant connections for harsh environments

Bulgin's new 6000 Series of waterproof power and data connectors have a quick and easy-to-use push-pull latching system with unique locking facility for fast and reliable connections. And they look good too!

Designed to meet IP66, IP68 and IP69K standards, the 6000 Series combines an easy-to-use push-pull mechanism with proven environmental sealing in a compact package, giving engineers a choice of power and data connections in a practical selection of body styles.

The 6000 Series is designed for long-term exposure in both harsh outdoor environments, where prevention of water ingress is critical, as well as demanding interior environments such as factory floors, where dust can be a problem. Its innovative design makes it ideal for any application where ease of connection, ease of use, space and appearance are important considerations.



Technical Specification

- Push-pull latching with unique 30° twist lock
- 2, 3, 8, 16 and 22 poles – ratings up to 16A, 277V
- USB V2.0 and ethernet (RJ45) data interfaces
- cULs, UL, VDE, CCC approvals (pending)
- IP66, IP68 and IP69K environmental sealing
- Temperature range: -40 to +120°C
- All plastic version: UL94-V0 rated, UV-stable, halogen free
- Metal body version: CNC-machined brass, nickel-plated

To find out more or to request a sample please contact:

t: +44 (0)1803 407752
e: connectivity@elektron-technology.com
w: bulgin.com

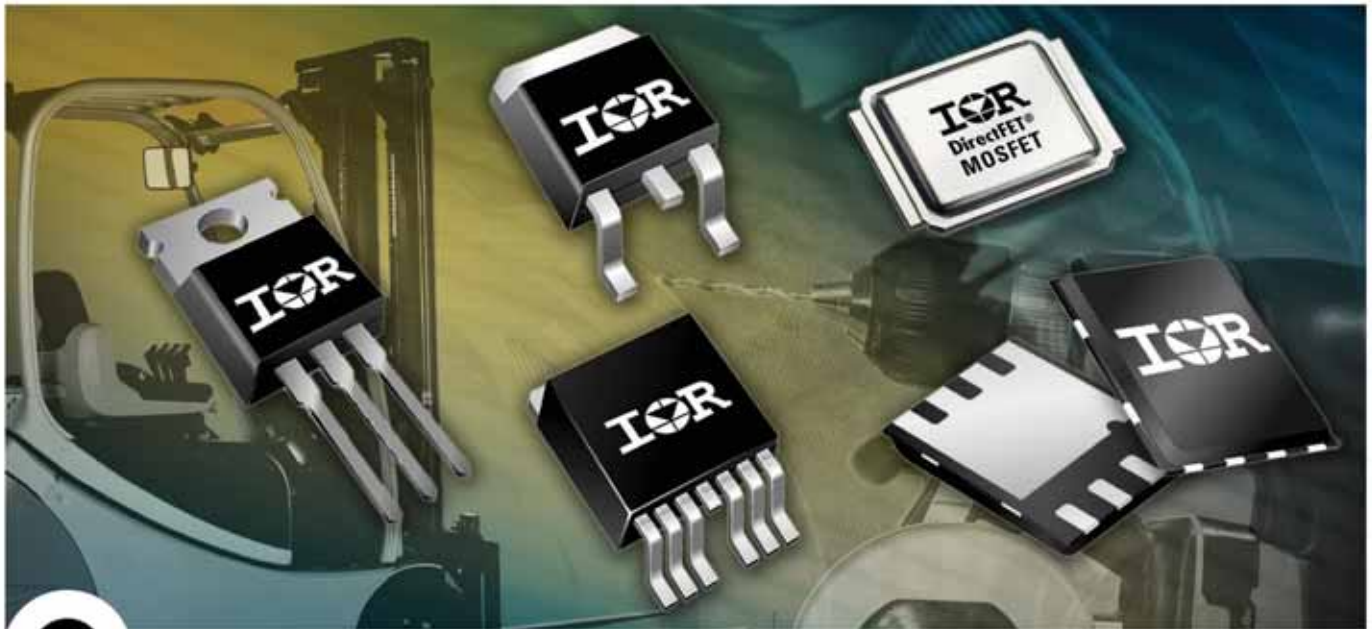

StrongIRFET™ Rugged, Reliable MOSFETs



Specifications

Part Number	$B_{V_{OSS}}$	$I_D @ 25^\circ C$	$R_{DS(on) max} @ V_{GS} = 10V$	$Q_g @ V_{GS} = 10V$	Package
IRFH7004TRPbF	40 V	100 A	1.4 mΩ	134 nC	PQFN 5x6
IRFH7440TRPbF	40 V	85 A	2.4 mΩ	92 nC	PQFN 5x6
IRFH7446TRPbF	40 V	85 A	3.3 mΩ	65 nC	PQFN 5x6
IRF7946TRPbF	40 V	90 A	1.4 mΩ	141 nC	DirectFET Medium Can
IRFS7437TRLpBF	40 V	195 A	1.8 mΩ	150 nC	D²-Pak
IRFS7440TRLpBF	40 V	120 A	2.8 mΩ	90 nC	D²-Pak
IRFS7437TRL7PP	40 V	195 A	1.5 mΩ	150 nC	D²-Pak 7pin
IRFR7440TRPbF	40 V	90 A	2.5 mΩ	89 nC	D-Pak
IRFB7430PbF	40 V	195 A	1.3 mΩ	300 nC	TO-220AB
IRFB7434PbF	40 V	195 A	1.6 mΩ	216 nC	TO-220AB
IRFB7437PbF	40 V	195 A	2 mΩ	150 nC	TO-220AB
IRFB7440PbF	40 V	120 A	2.5 mΩ	90 nC	TO-220AB
IRFB7446PbF	40 V	118 A	3.3 mΩ	62 nC	TO-220AB
IRFP7430PbF	40 V	195 A	1.3 mΩ	300 nC	TO-247

Features:

- Ultra low $R_{DS(on)}$
- High current capability
- Industrial qualified
- Broad portfolio offering

Applications:

- Battery Packs
- Inverters
- UPS
- Solar Inverter
- DC Motors
- ORing or Hotswap

For more information call +49 (0) 6102 884 311

or visit us at www.irf.com

International
IOR Rectifier
THE POWER MANAGEMENT LEADER

PCIM

EUROPE



International Exhibition and Conference
for Power Electronics, Intelligent Motion,
Renewable Energy and Energy Management
Nuremberg, 14 – 16 May 2013

Powerful?
...then you are right here!

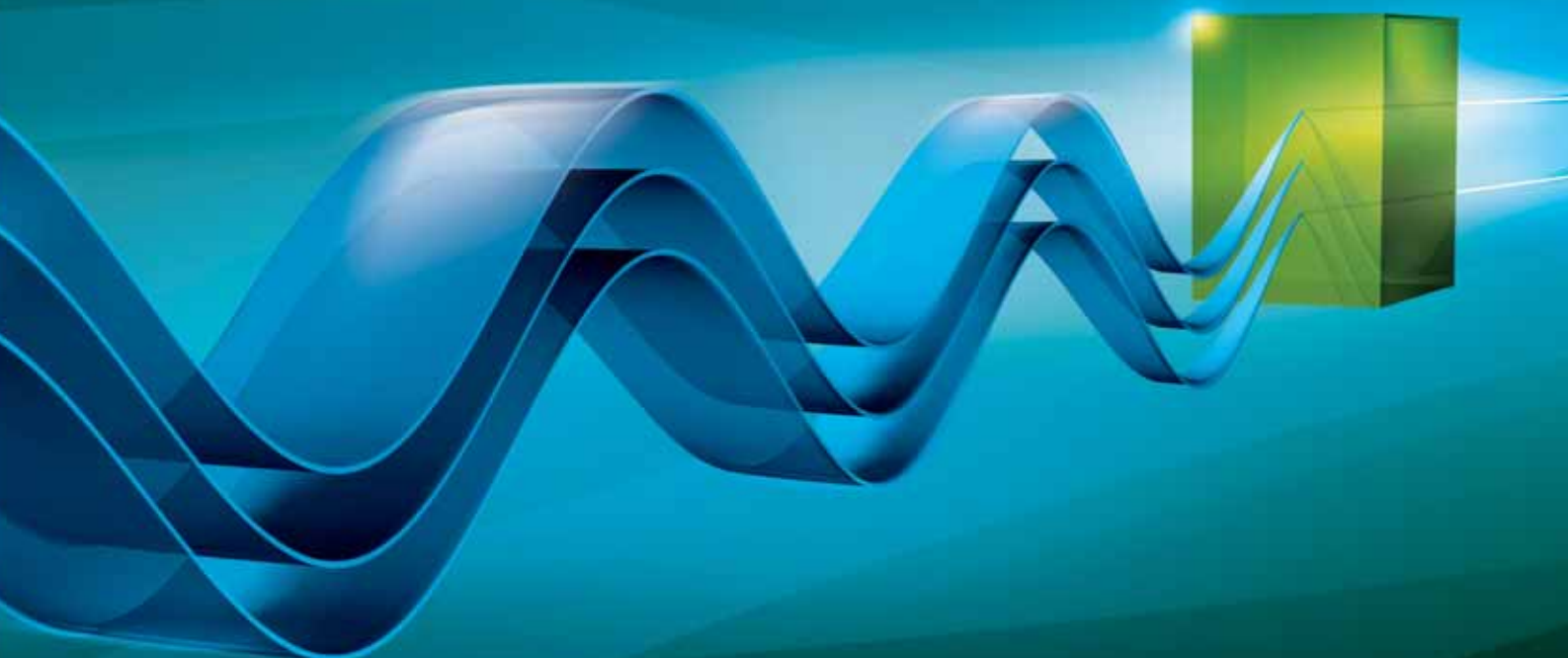

The marketplace for developers and innovators.
Future starts here!

More information at +49 711 61946-0
pcim@mesago.com or pcim-europe.com



Belden Provides Means of Securing Critical Manufacturing Systems Against Published Vulnerabilities

Belden Inc, global provider of signal transmission solutions for mission-critical applications, announced an update to the EAGLE Tofino Industrial Security Solution to include Security Profiles. This new feature is part of the EAGLE Tofino version 1.7 product release and addresses the post-Stuxnet trend of a dramatic escalation in the number of public disclosures of industrial control system vulnerabilities.

Tofino Security Profiles provide a simple way for automation system vendors to create and securely distribute rule and protocol definitions to address newly disclosed vulnerabilities. Control system customers benefit from a single, easy-to-deploy package of tailored rules that can be installed without impacting operations. The result is that manufacturing facilities can defend themselves against new threats quickly and effectively.

The discovery of the Stuxnet malware in 2010 alerted the security-researcher community to how easy it is to cause damage to industrial systems. Designed with a focus on reliability and safety, rather than security, devices such as PLCs (programmable logic controllers) and DCS (distributed control systems) are often easy to exploit.

In the year 2011 more Industrial Control System (ICS) vulnerabilities were made public (many with exploit code available on the Internet), than in the entire previous decade. Even more troubling, the publicly disclosed vulnerabilities are only a fraction of the conservatively estimated 100,000 or more vulnerabilities that exist in the field today.

Recently Schneider Electric utilized the EAGLE Tofino Security



Profile feature to defend against publicly announced vulnerabilities in its Modicon PLC product line. By utilizing the EAGLE Tofino's capabilities, they provided a method of defense for their customers that was immediately effective and that did not require any changes to automation equipment or network configurations.

Other improvements to the EAGLE Tofino product line in version 1.7 include: improved event logging, new VLAN support, enhanced OPC support and support for more protocols and products, among others.

www.tofinosecurity.com

www.hirschmann.com

www.belden.com

RELIABLE LOW POWER RADIO MODEMS FOR PERFORMANCE CRITICAL APPLICATIONS



ASCII in, ASCII out, 9600 baud wireless link, minimum effort

- Takes care of all over-air protocols
- European license-free 433 MHz ISM band & Custom frequencies
- Line-of-sight range over 500m
- Transmit power: +10dBm (10mW)
- Receiver sensitivity: -107dBm (for 1% BER)
- Addressable point-to-multipoint
- Conforms to EN 300 220-3 and EN 301 489-3
- No additional software required

Ideally suited for fast prototyping / short design cycle time

TXL2
& RXL2



Producing VHF and UHF, ISM band modules for over 25 years.

T: +44 (0) 20 8909 9595 sales@radiometrix.com
www.radiometrix.com

RADIOMETRIX
WIRELESS DATA TRANSMISSION

CAMBRIDGE MICROPROCESSOR SYSTEMS LIMITED

“Cambridge Microprocessor Systems Limited would like to offer our congratulations to the Electronics World publication on celebrating their centenary with this issue of the magazine”

We are specialists in low cost design and manufacture of embedded control products and custom designed electronic systems with over 30 years of experience behind us. For more details on our products and design services please visit our web site at <http://www.cms.uk.com> or give our engineers a call on 01371 606050.



FTDI CHIP

“Congratulations Electronics World”

FTDI Chip produces advanced silicon solutions that speed time-to-market and reduce development costs. Its USB products offer a simple route to USB migration by combining highly integrated ICs with royalty-free firmware and driver software. The company has expanded its “made easy” philosophy, with a family of display controllers that incorporate audio and touch functionality. www.ftdichip.com



LINEAR AUDIO

“Congratulations to the staff of Electronics World for 100 years of informative, inspiring and innovative articles”

Linear Audio is a half-yearly printed bookzine, bringing you in-depth and inspiring technical articles about audio and perception. Each 200-page advert-free Volume has articles by international authors like Douglas Self, Bob Cordell, Nelson Pass, Siegfried Linkwitz and others. Articles range from tube and solid-state to loudspeakers, test equipment and perception. Tel: +32 470 183 127 www.linearaudio.net



Hurrah! Congratulations!

- You have news to disclose - we have the right contacts. Thus we make sure your message reaches your target group. Since 1997 companies like Vishay, MIPS, Rutronik rely on our support in company and product PR. **Competence is no coincidence.**

Owner-operated full-service PR agency for electronics, embedded, green energy and ITC
Agentur Lorenzoni GmbH Tel +49 8122 55 91 70 pr@lorenzoni.de
www.lorenzoni-pr.eu

RADIOMETRIX

“Many congratulations to Electronics World magazine on this milestone 100th anniversary and the outstanding contribution to the electronics industry”

For over 25 years, Radiometrix have designed & manufactured the leading range of high integrity, wireless data links for performance critical applications. Our vast portfolio of radio products is ideally suited for demanding wireless applications requiring the best of reliability. Application areas include industrial & commercial telemetry, medical applications, tracking and defence. Custom design services also available.



TOSHIBA ELECTRONICS EUROPE

“Congratulations Electronics World on reaching your Centenary Edition”

Toshiba Electronics Europe (TEE) offers one of the industry's broadest IC and discrete product lines including high-end memory, microcontrollers, ASICs and ASSPs for automotive, multimedia, industrial, telecoms and networking applications. The company also has a wide range of power semiconductor solutions as well as storage products such as HDDs, SSDs, SD Cards and USB sticks.



AMPHENOL LTD

“Amphenol Ltd congratulates Electronics World on the remarkable achievement of attaining its 100th anniversary”

Amphenol Ltd offers full design and manufacturing services for a large range of connectors and interconnect solutions, including cable assembly, over-moulding and electronic packaging. We have full end-to-end manufacturing capability and access to low cost manufacturing sites around the world to complement our offering to customers globally. Accredited to AS9100, we are an innovative manufacturer of both connectors and interconnect systems for applications within the aerospace, military and industrial markets.



DIALOG SEMICONDUCTOR

“Congratulations Electronics World on reaching 100 years of publication”

Dialog Semiconductor creates energy-efficient, highly integrated, mixed-signal circuits optimised for personal portable, short-range wireless, lighting, display and automotive applications. We are headquartered near Stuttgart with sales, R&D and marketing operations all over the world. www.dialog-semiconductor.com



Current-Sensing ICs Now Offered In Ultra-Miniature Package

An innovative, new, ultra-miniature package offering has been introduced for the family of current sensor ICs available from Allegro MicroSystems Europe.



Allegro's smallest current sensor linear IC, the ACS711, is now housed in a 0.75mm thick low-profile QFN package measuring only 3mm x 3mm. This new micro-sized device is possibly the smallest fully integrated linear current sensor IC in the world.

With an internal resistance of only 0.6-milliohms, the new package exhibits very low power loss and thermal effects. With proper PCB design, it can be used for applications with over 30A continuous current while reducing power consumption by an order of magnitude over existing sense-resistor/op-amp solutions.

Factory programming provides for high accuracy in this IC, which also features an integrated fast-response fault output. Together these techniques deliver an exceptionally low current-sensing footprint available without compromising accuracy.

The ACS711 is designed for low-side or high-side sensing at voltages up to 100VDC.

www.allegromicro.com

COMPACT 40W BATTERY-BACKED SWITCH-MODE PSU WITH ADVANCED CONTROL FEATURES

Lincoln-based manufacturer Vxl Power has added a compact new 40W model to its Oracle family of battery-backed switch-mode power supplies, which are used in a wide variety of mission-critical applications. Particularly suitable for systems where the available space is restricted, the Oracle III-40 measures just 100 x 100 x 45mm and yet is equipped with all the advanced communications and control features of larger models in the range.

The PSU operates from a universal AC input and provides a main output for powering the load, together with a second output for charging an external 12V or 24V standby battery. In the event of mains failure, the PSU automatically switches to battery power.

The unit is available with either an RS232 port or an RS485 port with full Modbus functionality, making it easy for users not only to configure the variable main output voltage and charging current but also to remotely monitor system status and battery condition.

www.vxipower.com



HARTING ADDS SOLDER BUCKET CONTACTS TO HAR-LINK METRIC CONNECTOR RANGE

Harting is expanding its space-saving har-link metric connector range with a version equipped with solder bucket contacts.

Up to now, these connectors were supplied with an insulation displacement termination on the cable side only. The addition of solder bucket contacts now makes it easy to assemble harnesses for prototyping and test purposes without the use of special tooling.

With this new contact style, wires of sizes from AWG 30 to AWG 24 can be mounted on the cable side of the har-link connection, providing high flexibility and compatibility with a large range of cables available on the market. har-link is manufactured in accordance with IEC 61076-4-107 and is a compact, robust cable connector with 2.0mm spacing which guarantees excellent data transmission to the PCB in high-frequency networks and telecommunication applications. It can transmit data at speeds of up to 2Gbit/s on each twisted conductor, and is screened to deliver reliable performance in areas subject to high electromagnetic interference.

www.harting.com



ACCURATE FREQUENCY, RPM, PULSE MEASUREMENT

MMS Electronics, a UK-based supplier of display and sensor products, has introduced a new range of universal frequency to digital transducers (UFDC, USTI and USTI-EXT). These 2-channel converters work with any sensors from frequency-time signal domain group and convert frequency, period, its ratio and difference, duty-cycle, duty-off factor, PWM, time interval, pulse width and space, rotation speed, pulse number and phase shift to a digital signal.

The programmable accuracy UFDC-1 is 1 to 0.001 % and USTI (1 to 0.0005 %) in a wide frequency range; UFDC-1 up to 7.5MHz and USTI up to 9MHz (120/144 MHz with pre-scaling). The UFDC can work in 16 measuring and one generating modes (USTI 29 measuring modes). The USTI can also measure analogue and resistive sensor signals.

There are three serial interfaces: RS232 (including a master communication mode), I2C and SPI, and the small package size allows the converter to be designed within a sensor.

www.mms-e.co.uk

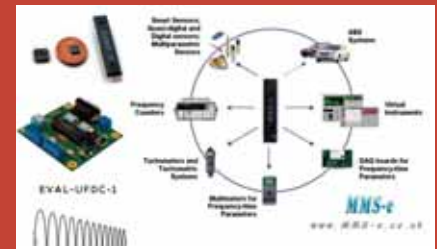

Interchangeable (RT Curve-Matched) NTC Thermistors

ATC Semitec's SP interchangeable series is a range of NTC thermistors that offers very high precision ($\pm 0.2^\circ\text{C}$ 0~70°C or better) at significantly lower pricing to that of existing interchangeable NTCs.

Readily available from stock, these new high accuracy NTCs mean that now a wider



range of users can cost-effectively achieve more accurate temperature control and thus more energy-efficient and comfortable working environments.

The main features of the SP thermistor range include R25 values from 1k Ω to 100k Ω ; accuracy of $\pm 0.2\text{K}$ from

0°C~70°C; temperature range of -40°C/+150°C; fast response and 2.6mm bead size among others.

Insulated and miniature (0.5mm dia) versions are available now.

www.atcsemitec.co.uk/ntc_thermistor.html

FTDI Expands Portfolio of Android Solutions

FTDI continues to encourage the progression of the Android Open Accessories initiative, with its FT311D USB Full Speed (12Mbit/s) host IC. This device is targeted at providing Android platforms (tablet PCs, smartphones, etc), with interconnectivity to external systems through USB. Running off a 3.3V supply, it draws just 25mA in full operation (48MHz) and 128 μA in standby mode.

The FT311D can bridge the USB port to six different user-selectable interface types (GPIO, UART, PWM, I2C master, SPI slave and SPI master). This is complemented by the J2XX Java driver for USB peripheral implementations. By utilising the J2XX and compiling it with the user's application, the USB driver is automatically loaded onto the Android platform without any need for user intervention. These new offerings provide system designers with a quick and easy way to enable Android platforms to control their end products.

www.ftdichip.com

HAMEG INSTRUMENTS INCREASES THE FREQUENCY RANGE FOR ITS SPECTRUM ANALYZERS

Hameg Instruments increased the frequency range for all spectrum analyzers in the 1000 series from 1GHz to 1.6GHz. With the purchase of a HMS1000, HMS1010 or HMS1000E, Hameg customers will experience an immediate increase of 60% more frequency range at no extra cost.

This added value applies not only to new instruments; all products delivered after July 01, 2012, have been tested at the factory to ensure compliance with the new specifications and can be upgraded accordingly.

The free upgrade to 1.6GHz is also available for all HMS1000 products purchased prior to July 01, 2012, subject to certain restrictions. However, to ensure compliance with all specifications over 1GHz, Hameg recommends returning the spectrum analyzer to the Hameg Service Center.

For 160 EUR (plus tax), Hameg will do a firmware upgrade to test and synchronize the instrument. This will guarantee correct measurement results, including the expanded frequency range.

www.hameg.com



congatec Presents Windows Embedded Compact 7 Qseven

congatec has announced a Windows Embedded Compact 7 version of its conga-QMX6 Qseven module based on the Freescale i.MX6 ARM Cortex A9 processor. Windows Embedded Compact 7 (WEC7) is the latest generation of Windows CE operating systems designed for innovative embedded applications such as those based on the Qseven form-factor.

WEC7 provides a 32-bit hard real-time operating system with Silverlight support, a customizable user interface, a new multimedia player, Internet Explorer with Flash 10.1 and a powerful development tool. In addition, it provides customized development and design tools for programmers; XAML and C++ can be used.

A ready-to-use WEC7 board support package is provided in partnership with Adeneo for the conga-QMX6 Qseven module with Freescale's i.MX6 ARM Cortex A9 processor. As a result, customers worldwide now benefit from a cost-effective end-to-end solution that accelerates the development of their embedded applications.

www.congatec.com



VECTOR INTEGRATES AUTOSAR EXTENSIONS IN ITS E/E DEVELOPMENT PLATFORM PREEVISION

Besides handling requirements management, hazards and risk analysis (ISO 26262), the current PREEvision 6.0 version from Vector now also includes functions for designing AUTOSAR architectures.

Vector released this version for E/E architecture development, which allows efficiency to be improved by using PREEvision with its universal approach to modeling E/E systems. It begins with requirements and extends to the logical architecture level, the hardware and software levels and finally the geometry. Many new functions have been implemented in Version 6.0 for developing AUTOSAR ECUs.

In the new version, AUTOSAR system descriptions can now be created, which include the internal behaviour of software components. PREEvision supports exporting of these system descriptions that are extracted from the ECU. These components and their containers can be individually updated based on a system or software component description. This simplifies data exchange (round-trip) between PREEvision and other AUTOSAR tools from Vector and third party suppliers.

www.vector.com



Elektron Launches Online Stock Availability Tool

Elektron Technology has introduced a Distributor Inventory Search tool allowing customers to check the worldwide availability of components from its three connectivity brands – Arcoelectric, Bulgin and Sifam. This convenient web-based system allows customers to search for up to three different products at a time using complete or partial product numbers, and provides comprehensive stock level information for all Elektron distributors within the selected region, either Europe or the Americas.

Search results are provided as an easy-to-interpret list, grouped by product, listing all of the distributors which have the selected items in stock, as well as the total number of units available from each distributor. Customers can then simply choose their preferred source and click on the appropriate link to be taken directly to the distributor's website. Distributors with an online purchasing system are indicated with a shopping cart icon, and links to these websites go directly to the ordering page.

www.bulgin.com



NEW ADAPTICS LINE FROM WINSLOW ADAPTICS AIDS BREAD BOARDING

Winslow Adaptics has introduced a range of products that will aid the process of bread-boarding, especially where stabilized power supplies are required. Operating from any 5.5V-6V supply, these products which can be in either a 14- or 16-pin dual-in-line package, can offer a range of stabilized supplies from 0.8V to 3.3V at 1A.

Based around a synchronous buck regulator using a 4MHz switching rate, these devices have been designed for low noise and EMI. A low ripple current, typically less than 5mV, short-circuit protection and over-current protection makes them suitable for most applications.

The 14-pin package, will give any one of the six available voltages (0.8, 1.2, 1.25, 1.8, 2.5 or 3.3V) either factory-set or user-selectable via a small in-line switch, mounted on the device. The second package, 16-pin DIP, can supply two factory-set 1A supplies from any of the available voltages.

www.winslowadaptics.com

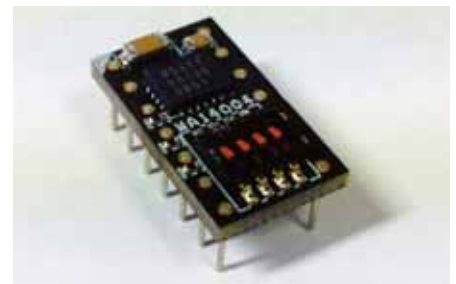

IR'S HIGH CURRENT IR3847 GEN3 SUPRIBUCK OFFERS SUPERIOR PERFORMANCE

International Rectifier (IR) has introduced the IR3847 high current Point-of-Load (POL) integrated voltage regulator that extends the current rating of IR's third generation SuprIRBuck family up to 25A in a compact 5 x 6mm package.

As a result of a new thermally-enhanced package using copper clip and several proprietary innovations in the controller, the IR3847 can

operate at 25A without a heatsink, and it helps reduce PCB size by 20% compared to alternative integrated solutions and 70% compared to discrete solutions that use a controller and power MOSFETs. A complete 25A power supply solution can be implemented in as little as 168mm².

The new device integrates IR's latest generation power MOSFETs with a feature-rich, third generation SuprIRBuck controller that includes post-package precision dead-time trimming to optimize losses, and internal smart LDO to optimize efficiency across the entire load range. The IR3847 features a proprietary modulator scheme that reduces jitter by 90% compared to standard solutions.

<http://www.irf.com/>



ITT's Interconnect Solutions Business Launches Enhanced Website

ITT Corporation announced its Interconnect Solutions business has launched an enhanced website at www.ittcannon.com that offers its customers and other users a variety of features that improve the usability, functionality and performance of the site.

New features include an updated design, the ability to easily search products and part numbers, improved product descriptions and specifications, and a new product catalog library. Other enhancements include the ability to configure part numbers, download select two-dimensional drawings and three-dimensional models, and download data sheets for individual part numbers.

"The Interconnect Solutions team is committed to enhancing our capabilities to better serve our customers, and this website is just one example of our continuing efforts to provide a premier customer experience," said ITT's Interconnect Solutions VP of marketing, Anh Phan. "Our goal was to re-imagine our site from a customer's point of view, and we are now offering a fresher, more engaging and user-friendly site."

www.ittcannon.com



NEW AVX MLCC SERIES FEATURES NEAR-PURE SILVER ELECTRODES FOR HIGH CONDUCTIVITY

AVX Corporation has introduced a new series of microwave MLCCs with near-pure silver (Ag) electrodes, which both enhance performance and mitigate cost. Exhibiting higher conductivity than competing non-precious metal RF capacitors, AVX's new UQ Series MLCCs feature ultra-low ESR, high Q, high self-resonance and a capacitance range spanning 0.1pF to 1000pF. Ideal applications for the UQ Series include RF power amplifiers, low noise amplifiers, filter networks and MRI systems.

Lead-free and RoHS compliant, AVX's high-performance UQ Series MLC RF capacitors are available in seven voltages, ranging from 50-500V, and in eight capacitance tolerances, ranging from $\pm 0.1\text{pF}$ to $\pm 20\%$.

Competitively priced with other non-precious metal RF capacitors, the series is also available in six case sizes: 0605, 1210, 0709, 0402, 0603 and 0805, and with three termination styles: nickel barrier Sn/Pb (60/40), 100% tin and non-magnetic barrier/tin.

The series is rated for use in temperatures ranging from -55°C to $+125^{\circ}\text{C}$.

www.avx.com

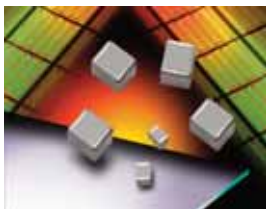

HARWIN INVESTS ANOTHER £1M IN STATE-OF-THE-ART CONNECTOR MANUFACTURING FACILITY

Harwin, manufacturer of hi-rel connectors and SMT PCB hardware, has invested more than £1m in new manufacturing equipment at its worldwide headquarters and manufacturing centre in Portsmouth, UK. The company has a policy of replacing all plants within five years, ensuring it has a state-of-the-art production facility.

The investment includes two new Arburg electronic moulding machines which are currently being employed to ramp up production of Harwin's new 1.25mm pitch high-performance Gecko connector family. Other new equipment includes EDM wire erosion, hole drilling and die sinking machinery from AgieCharmilles, a MAST 3 wetting balancing machine and substantial amounts of tooling. This new investment is on top of a new £350,000 water treatment plant installed by the company last year.

"Our philosophy is that it is only by keeping all manufacturing stages under our control here in Portsmouth that we will be able to constantly innovate and deliver new, high-quality products to the market," said Chairman Damon De Laszlo (pictured).

www.harwin.co.uk



MOUSER SIGNS DISTRIBUTION AGREEMENT WITH COILCRAFT OVER MAGNETIC COMPONENTS

Mouser Electronics has signed an international distribution agreement with Coilcraft, a magnetic component manufacturer, across the regions of Europe, Asia, Mexico and South America. Through this partnership Mouser is now stocking a wide range of Coilcraft's magnetic and inductive products for immediate shipment.

Coilcraft provides magnetic components, including high-performance RF chip inductors, power magnetics and filters in a variety of packages and prices. Designer's kits are offered to help engineers learn the capabilities of these high-performance inductors. Coilcraft supports the design process by providing hundreds of design tools, models, S-Parameters and application notes free of charge.

"This agreement with Coilcraft helps further our commitment to providing the newest products and technologies for design engineers from industry-leading suppliers," said Glenn Smith, Mouser's President and CEO. "Design engineers will now have easy access to Coilcraft's advanced technologies, backed by Mouser's unsurpassed customer service and best-in-class logistics."

www.mouser.com



GAN SYSTEMS EXPANDS WITH NEW UK LOCATION

Canada-based GaN Systems Inc, a developer of gallium nitride power switching semiconductors, announced the opening of a new office located in Reading, UK. This expansion of the company's European operations will aid the company in continuing to impact key industries, like manufacturing and automotive, where the need for clean technology power conversion applications continue to grow. GaN Systems's head office is currently located in Ottawa, Canada.

"GaN Systems new office facility comes in response to a strong pull from our growing base of European customer partners," said Geoff Haynes, the company's UK based VP of Business Development. "The company has a strong focus on collaborating across the manufacturing value chains for global power electronics markets to accelerate the adoption, and drive the cost of manufacture of GaN components. That can only be achieved through a strong local technical presence."

In addition to sales offices, the new location will include technical support and seminar facilities.

www.gansystems.com



IC DESIGN CONSULTANCY SONDREL COMPLETES THIRD SUCCESSFUL 28NM TAPE-OUT

Sondrel, a system-to-silicon IC design consultancy, has just completed its third 28nm design this year for a leading communications company, and is closing on two more at this node. Sondrel has worked on over 200 IC designs at all nodes down to 20nm and chip sizes over 700mm².

The fact that the company has so many successful tape-outs at 28nm convinces CEO Graham Curren that 28nm will be the preferred geometry for complex chips for some time to come: "As an independent design consultancy we have customers in all sectors – mobile, computing, graphics, consumer, automotive – so it is interesting that so many of our projects are based around 28nm. We think this is perhaps because 28nm appears to be a strong, stable process with good yield and performance characteristics, and is therefore more attractive than 40nm or the still new 20nm node."

www.sondrel.com



Designing Analogue Instruments with EA eDIPTFT

The EA eDIPTFT intelligent displays from MMS Electronics offer abundance of clever graphics functions and now have extra commands for the design of rotating or needle pointing instruments such as compass or level indication.

With the free LCD tool development software, users can adjust picture, colours, text, scaling and pointer rotation.

The instruments are controlled directly from the onboard analogue port, touch-screen or via the display interface. Displays have serial, I2C and SPI interface as standard and are supplied with eight integrated fonts, but more can be added with the software tools.



There are over 112 embedded graphic commands available, including drawing lines, boxes, bar graph, rotary instrument gauges, portrait and landscape modes, zoom, pull down menus, display BMP, JPEG, GIF or animated GIF.

The EVAL-eDIPTFT development kit includes the display, development software and interface board with USB, RS-232 and RS-485.

www.mms-e.co.uk

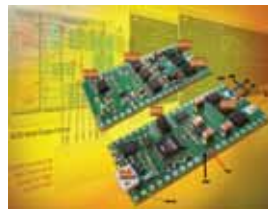

ARM CORTEX DEVELOPMENT BOARD FOR BLDC MOTOR CONTROL

Toshiba Electronics Europe (TEE) announced a pre-configured development board for rapid implementation of motor control applications

using its ARM Cortex-M3 family of microcontrollers. Developers can use the low-cost SigmaBoard as a starter kit, reference design or a standalone solution for field-orientated control (FOC)/vector control of brushless DC (BLDC) motors with ratings to 36V and 2A.

The SigmaBoard is a double-sided 2.5cm x 5cm PCB featuring a 'digital side' and an 'analogue side'. The digital side incorporates a Toshiba TMPM373 microcontroller; a USB-to-serial interface with a default transmission rate of 115kbps; a USB connector for a host PC; an RGB LED to indicate motor phase; interfaces for U, V and W motor phase outputs; and high-side MOSFETs. The analogue side comprises: gate drivers; a current measurement circuit with a 50mΩ shunt resistor and amplifier for current sensing; an overcurrent comparator; and low-side MOSFETs.

www.toshiba-components.com

HIGHLY INTEGRATED, EASY-TO-USE GRAPHIC CONTROLLER

FTDI Chip's FT800 is the initial offering in its Embedded Video Engine (EVE) family. Targeted at cost-effective, intelligent QVGA and WQVGA TFT display panels, the FT800 has an object-oriented approach – where objects can be

images, fonts, audio elements, etc. It renders images line by line with 1/16th pixel resolution, eliminating the expense of traditional frame buffer memory. Four-wire resistive touch sensing is supported, with built-in intelligent touch detection. An embedded audio processor allows midi-like sounds combined with pulse code modulation (PCM) for audio playback.

The combination of display, audio and touch on a single-chip solution

enables engineers to produce superior graphic user interfaces (GUIs) while keeping cost and board space utilisation low.

FTDI Chip has collaborated with MikroElektronika to use its Visual TFT graphic development solution. Through it, EVE objects can be dragged and dropped onto a palette in order to build complex applications.

www.ftdichip.com



Telephone: 01840-770028
 Fax: 01840-770705
 7 Gavercoombe Park Tintagel, Cornwall PL34 6DS
www.kestrel-electronics.co.uk

KESTREL
Electronic Components Limited

PIC10F222-I/P	0.3	PIC16F886-I/SO	0.91
PIC12F508-I/SN	0.26	PIC16F887-I/PT	1.16
PIC12F508-I/P	0.3	PIC16F1823-I/SP	0.68
PIC12F629-I/SN	0.41	PIC16F1827-I/SO	0.65
PIC12F629-I/P	0.45	PIC16F1933-I/SS	0.66
PIC12F675-I/SN	0.42	PIC16F1934-I/PT	0.93
PIC12F675-I/P	0.53	PIC16F1939-I/PT	1.21
PIC12F683-I/SN	0.54	PIC18F2525-I/SP	2.39
PIC16F683-I/P	0.59	PIC18F4520-I/PT	2.21
PIC16C54C-04/P	0.72	PIC18F8720-I/PT	5.01
PIC16F616-I/SL	0.41	PIC18F8722-I/PT	4.35
PIC16F616-I/P	0.54	PIC18F45K20-I/PT	1.06
PIC16F628A-I/P	0.88	PIC18F45K22-I/PT	1.23
PIC16F628A-I/SO	0.85	PIC18F67K22-I/PT	1.92
PIC16F648A-I/P	0.89	PIC18F87K22-I/PT	2.01
PIC16F676-I/P	0.68	ATMEGA8A-16PU	0.81
PIC16F684-I/P	0.68	M27C4001-10F1	2.75
PIC16F818-I/SO	0.88	M27C2001-10F1	2.81
PIC16F883-I/SP	0.98	M27C1001-10F1	2.44
PIC16F883-I/SO	0.82	M27C512-10F1	1.95
PIC16F886-I/SP	1.04	M27C256B-10F1	1.75

We can also supply Maxim/Dallas, Lattice, Linear Tech
PLEASE VISIT OUR WEB SITE FOR FULL LIST

THE MOST RELIABLE STORAGE FOR INDUSTRIES

Industrial MEMORY SOLUTIONS

www.apacer.com

Industrial SSD SOLUTIONS

embedded@apacer.nl

INDUSTRIAL MEMORY SOLUTIONS
 NAND FLASH PRODUCTS & DRAM MODULES

- Industrial Temperature Grade (-40°C to +85°C)
- Controlled BOM
- PCN Process
- SLC NAND Flash
- Small Form Factor

www.swissbit.com

Need a True Automotive Expert?

Teledyne LeCroy Automotive Oscilloscopes



Efficient Automotive Design and Debug

Leading Technology

- 8 Channel Solution
- HD4096 True 12-bit Technology:
 - 16x More Vertical Resolution,
 - Unmatched Measurement Precision
- 36 Digital Channel Mixed Signal Solution

Widest Range of Serial Data Tools

- CAN, LIN, FlexRay™
- MOST, BroadR-Reach, SENT, PS15
- Manchester & NRZ Configurable Protocol Decode
- I²C, SPI, UART, Ethernet, USB, PCI-Express etc.

teledynelecroy.com/europe



TELEDYNE LECROY
Everywhere you look™



uk.mouser.com

The Newest Products for Your Newest Designs®

The Next Big Thing Is Here.

NEWEST PRODUCTS



More New Products
More New Technologies
More Added Every Day

Authorized distributor of semiconductors
and electronic components for design engineers.



**MOUSER
ELECTRONICS.**